



M design
Spijlen en Panelen



Classical Pickets and Panels

Paletti e Pannelli classici

Arteferro pickets and panels are amongst the most important items in the composition of an infill of a balustrade or fence. The classic design means you can create structures with a refined taste and an unmistakable and timeless style, typical of traditional wrought iron items.

I paletti e pannelli Arteferro sono tra gli elementi più importanti nella composizione del tamponamento di un parapetto o di una recinzione. Il design classico consente di realizzare strutture dal gusto ricercato e dallo stile inconfondibile ed intramontabile, tipico dei manufatti in ferro battuto tradizionali.

arteferro



4

Classical Pickets and Panels
Paletti e Pannelli classici

| | | | |
|---|---------------------------|--------------------------------|--------------|
| A | Forged pickets | Paletti forgiati |pag.3 |
| B | Stamped pickets | Paletti coniati |pag.19 |
| C | Tube pickets | Paletti in tubo |pag.33 |
| D | Pickets with twisting | Paletti con torciglione | pag.39 |
| E | Pickets with big twisting | Paletti con torciglione grande | pag.48 |
| F | Pickets with baskets | Paletti con pigna | pag.49 |
| G | Pickets with scrolls | Paletti con ricci | pag.52 |
| H | Shaped pickets | Paletti sagomati | pag.58 |
| I | Special pickets | Paletti speciali | pag.60 |
| L | Shaped panels | Pannelli sagomati | pag.62 |
| M | "S" shaped panels | Pannelli ad "esse" | pag.66 |
| N | Panels with scrolls | Pannelli con ricci | pag.73 |



A lot of pickets and panels have been classified to make it easier for you to find what you want quickly and easily. Starting with the central motif, you can find your article by process as well as matching decorations.

Molti paletti e pannelli sono stati classificati per dare la possibilità di trovare in modo veloce e pratico l'articolo desiderato. Parti dal motivo centrale troverai il tuo articolo con la lavorazione e i decori abbinabili.

The first forged picket in our factory was art. 98/1 and still in production

Il primo paletto forgiato nelle nostre fucine è stato l'art. 98/1 ancora oggi in produzione

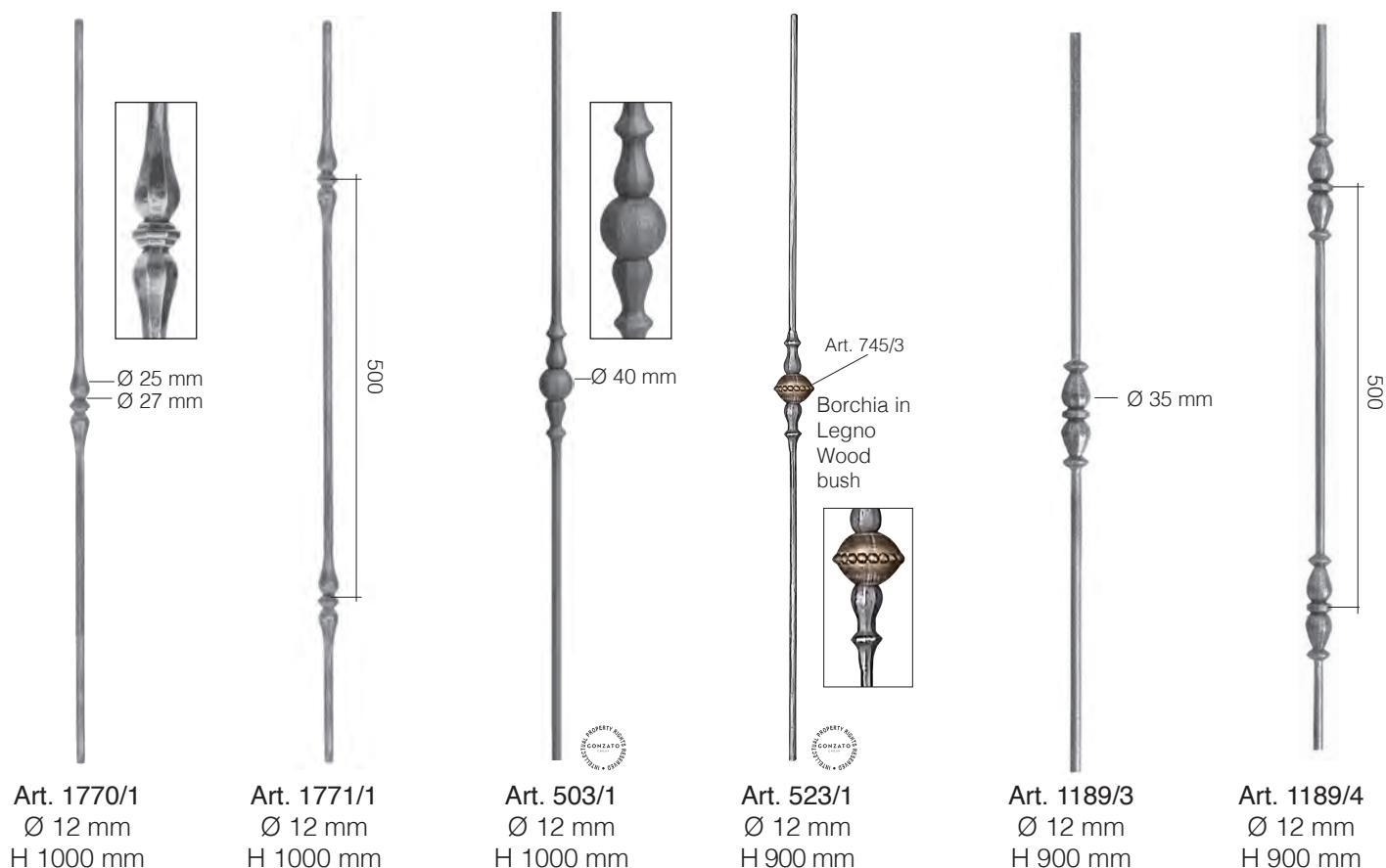

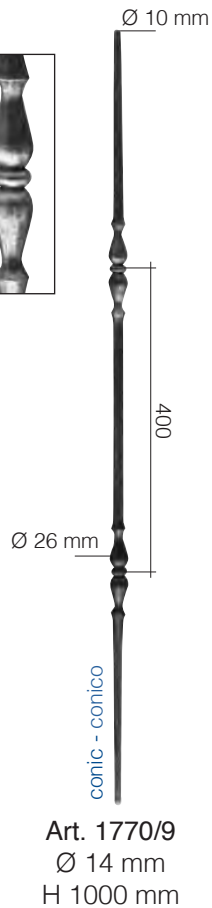
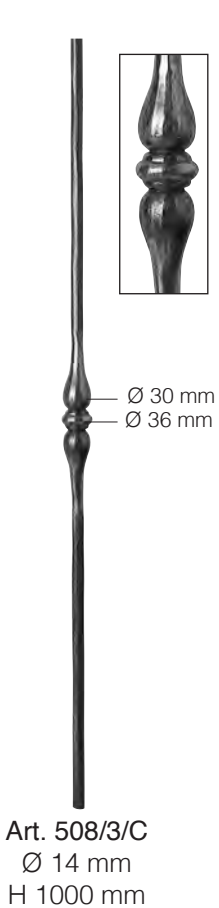
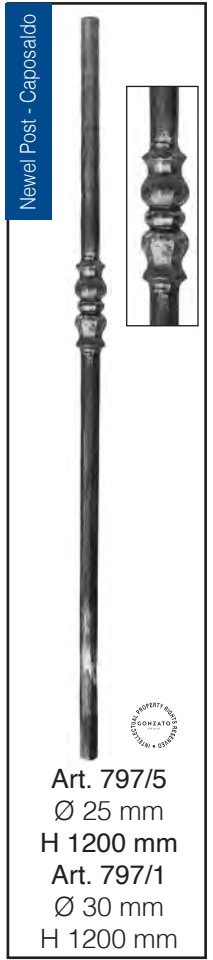
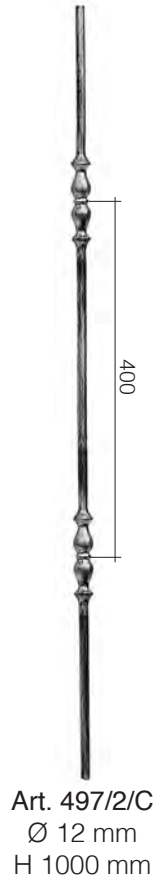

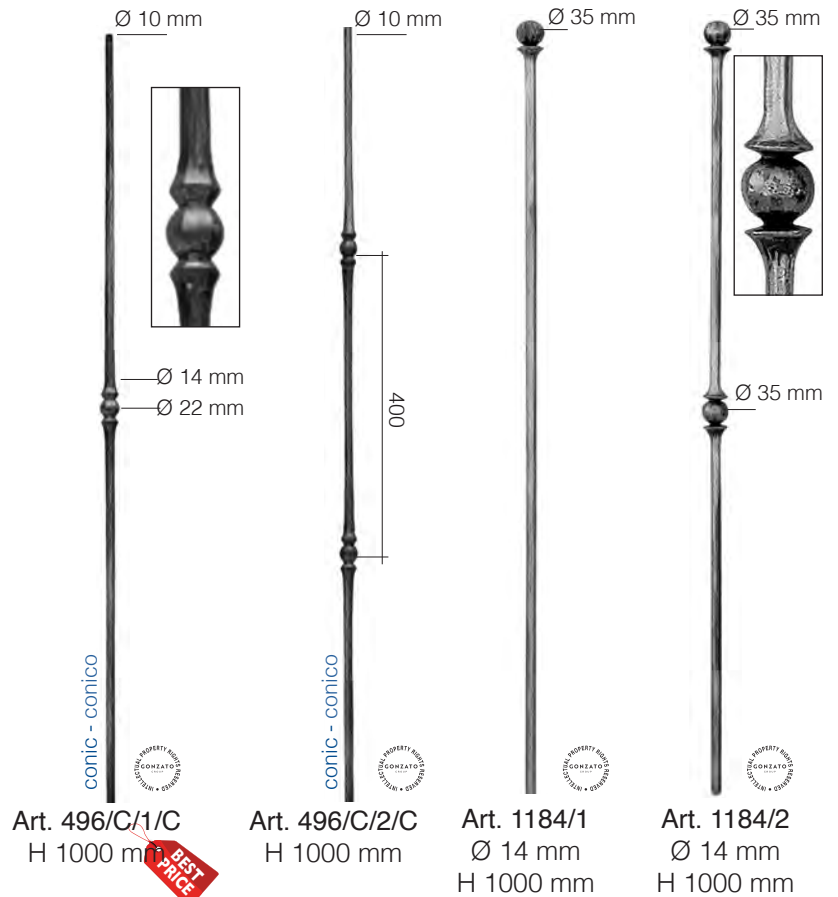
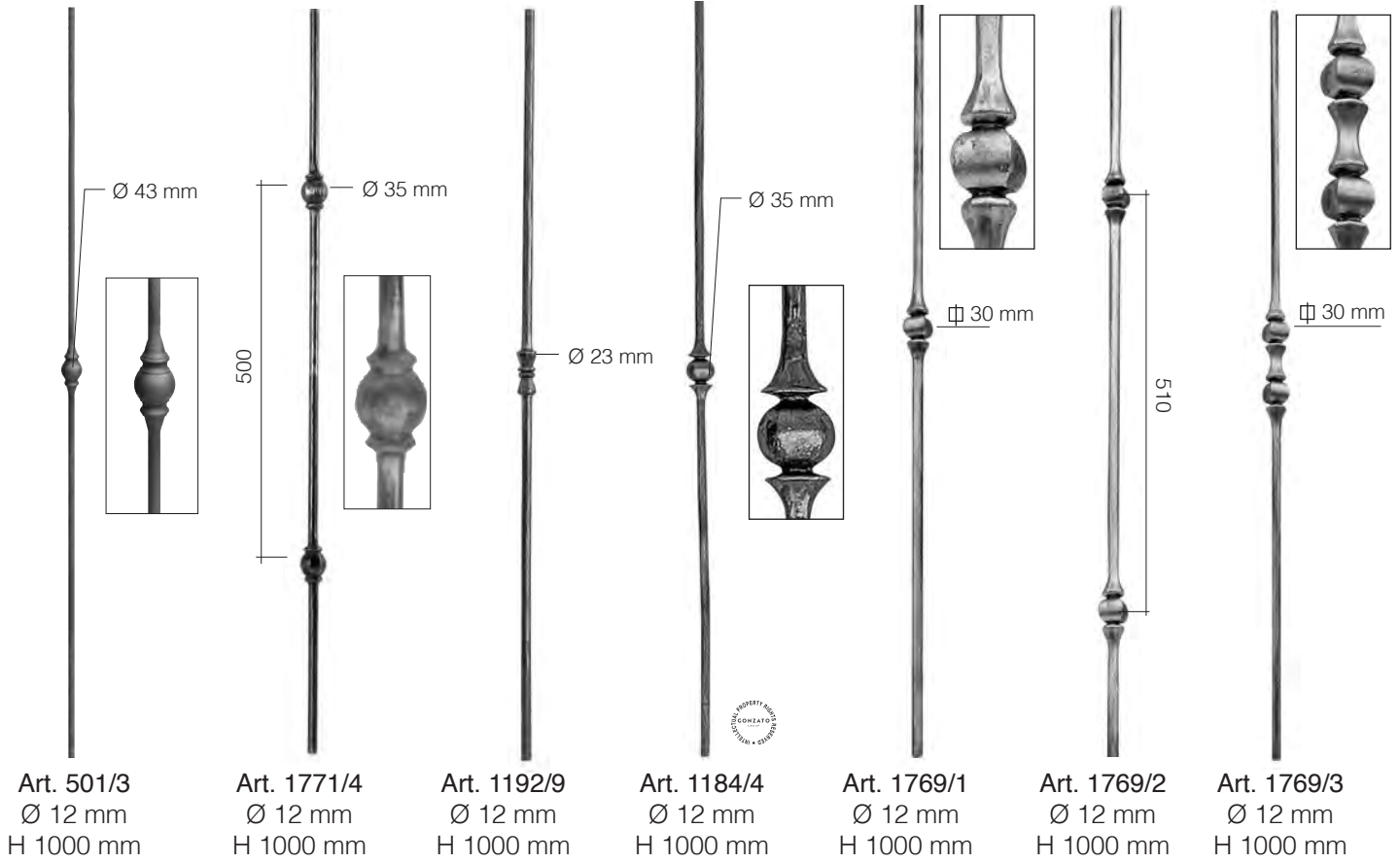



Art. 1187/4
Ø 14 mm
H 1000 mm



Art. 504/2/C
Ø 14 mm
H 1000 mm

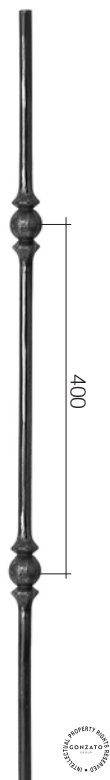

Art. 504/3/C
Ø 14 mm
H 1000 mm



Art. 1192/7
Ø 14 mm
H 1000 mm

Newel Post - Caposaldo



Ø 60 mm

Art. 1769/5
Ø 25 mm
H 1200 mm
Art. 1769/6
Ø 30 mm
H 1200 mm

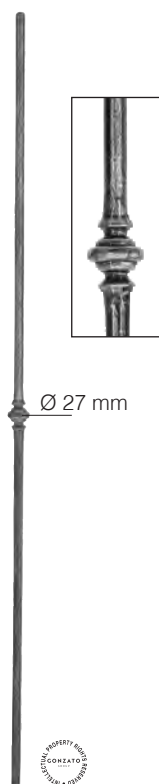

Art. 1770/2
Ø 12 mm
H 1000 mm



Art. 1771/2
Ø 12 mm
H 1000 mm

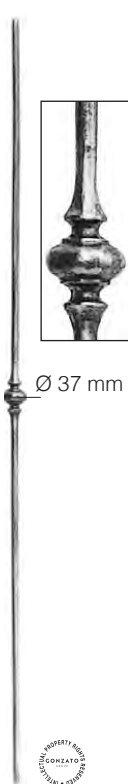

Art. 499/1/C
Ø 12 mm
H 1000 mm

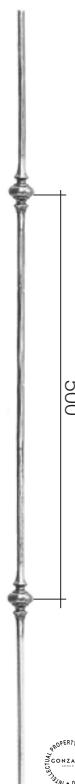

Art. 499/2/C
Ø 12 mm
H 1000 mm



Art. 1770/3
Ø 12 mm
H 1000 mm



Art. 1771/3
Ø 12 mm
H 1000 mm

Newel Post - Caposaldo



Art. 797/6
Ø 25 mm
H 1200 mm
Art. 797/2
Ø 30 mm
H 1200 mm
Art. 797/7
Ø 40 mm

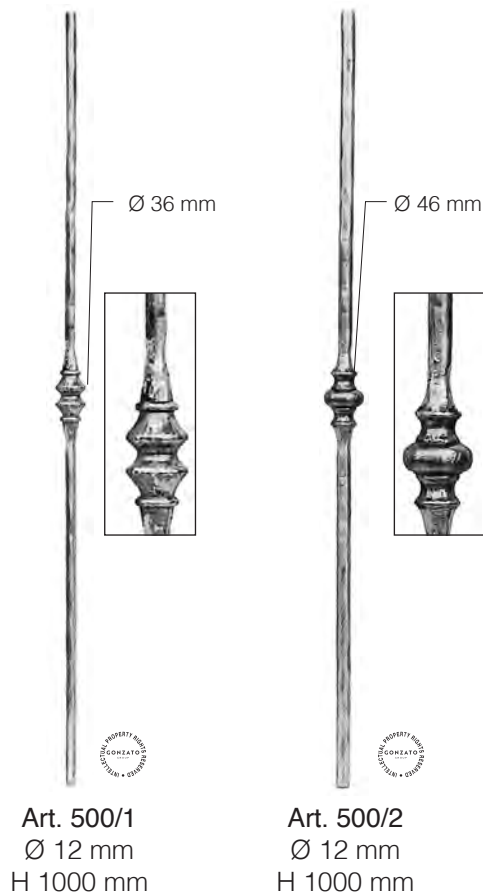
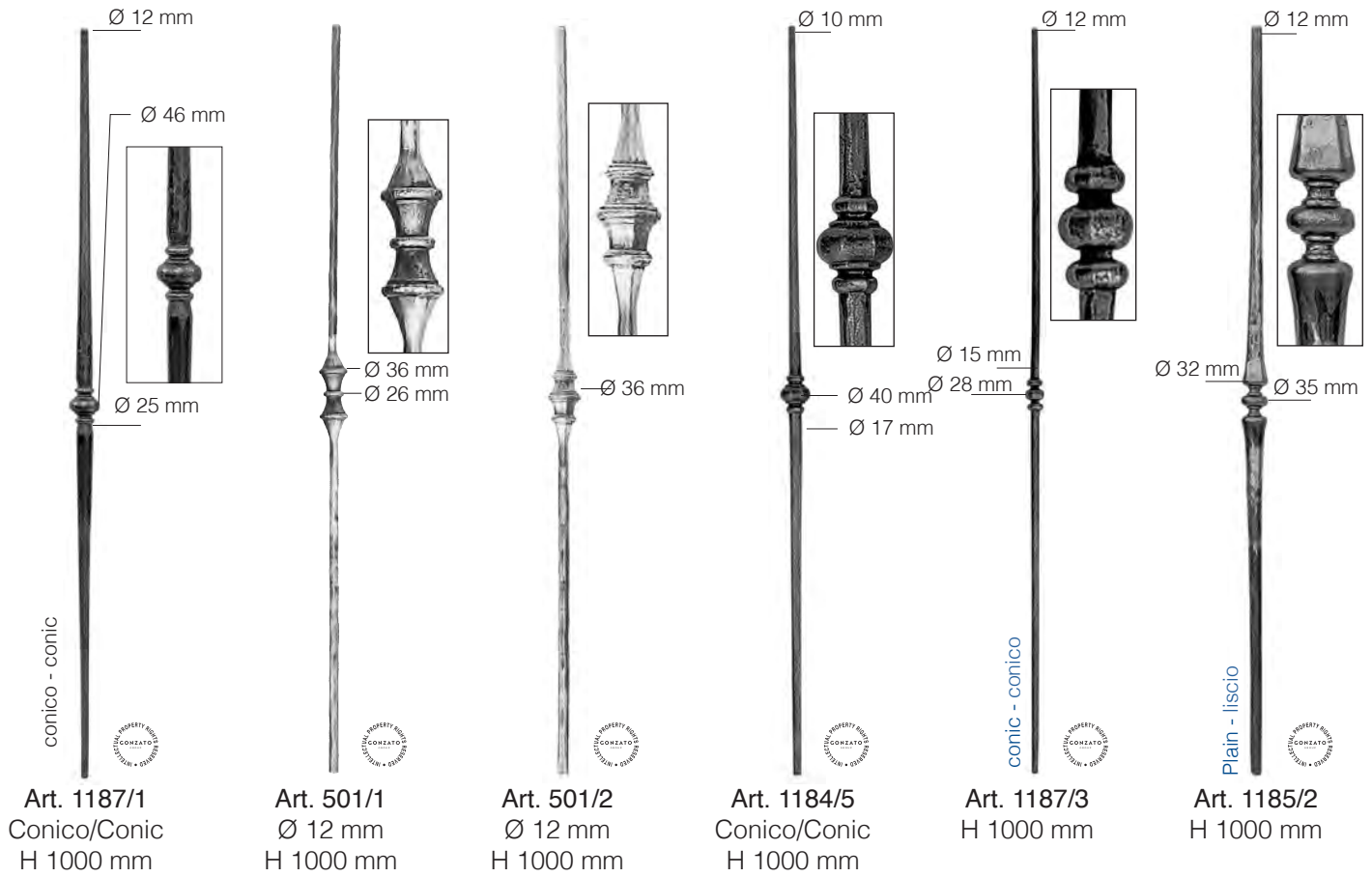



Art. 1198/2
Ø 30 mm
H 500 mm
Threaded hole
Foro filettato
Ø 12 MA



Art. 1198/1
Ø 30 x 30 mm
H 500 mm
Threaded hole
Foro filettato
Ø 12 MA



Art. 1198/5
Ø 12 mm
H 450 mm
Threaded hole
Foro filettato
Ø 8 MA



Art. 1198/6
Ø 12 x 12 mm
H 450 mm
Threaded hole
Foro filettato
Ø 8 MA

USE THE BUSH YOU
PREFER!
see pag.329

USA
LA BORCHIA
CHE VUOI!
vedi pag.329

example
esempio

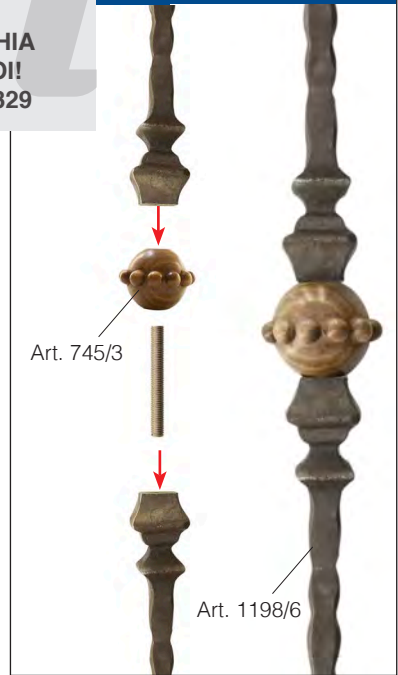

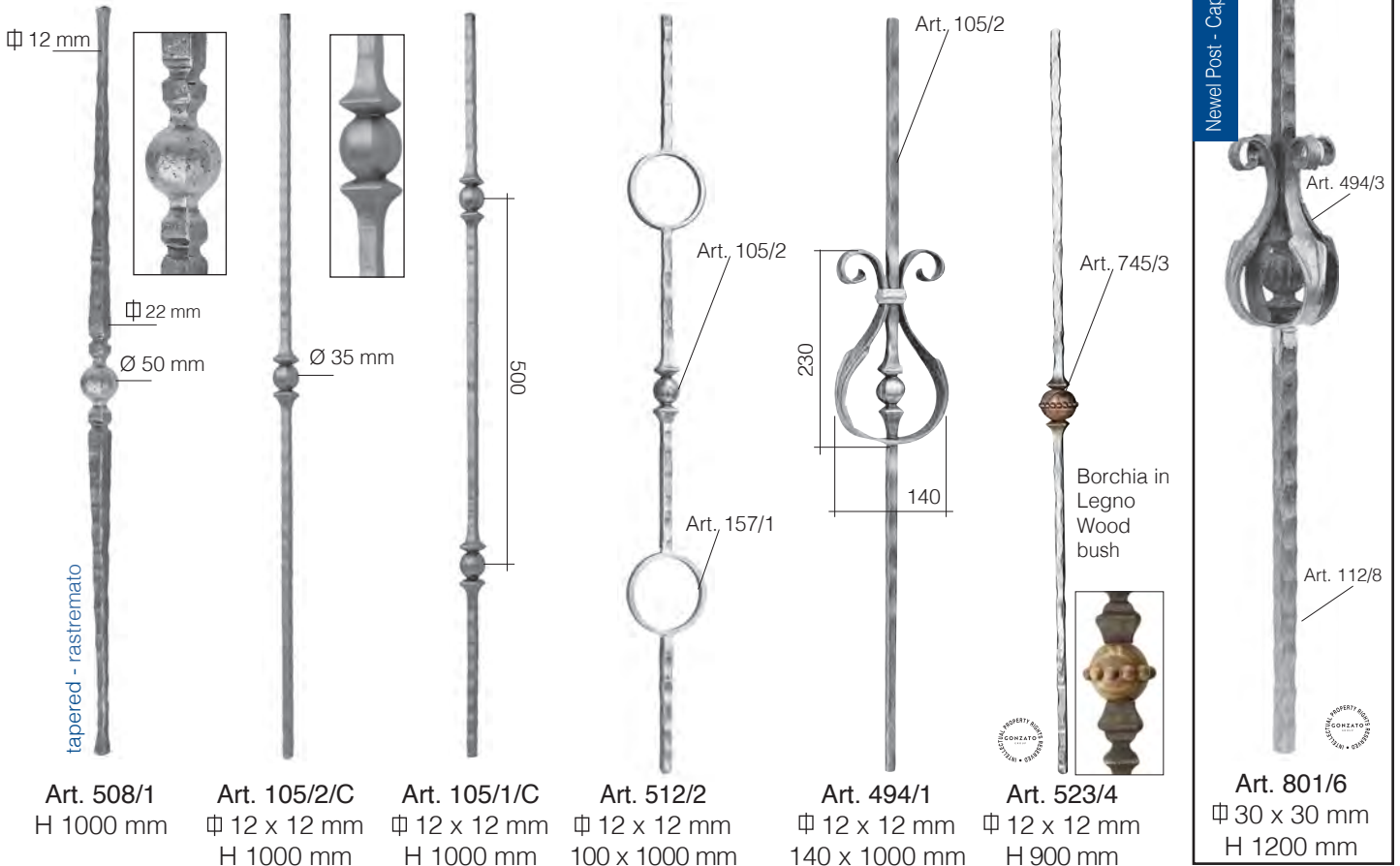
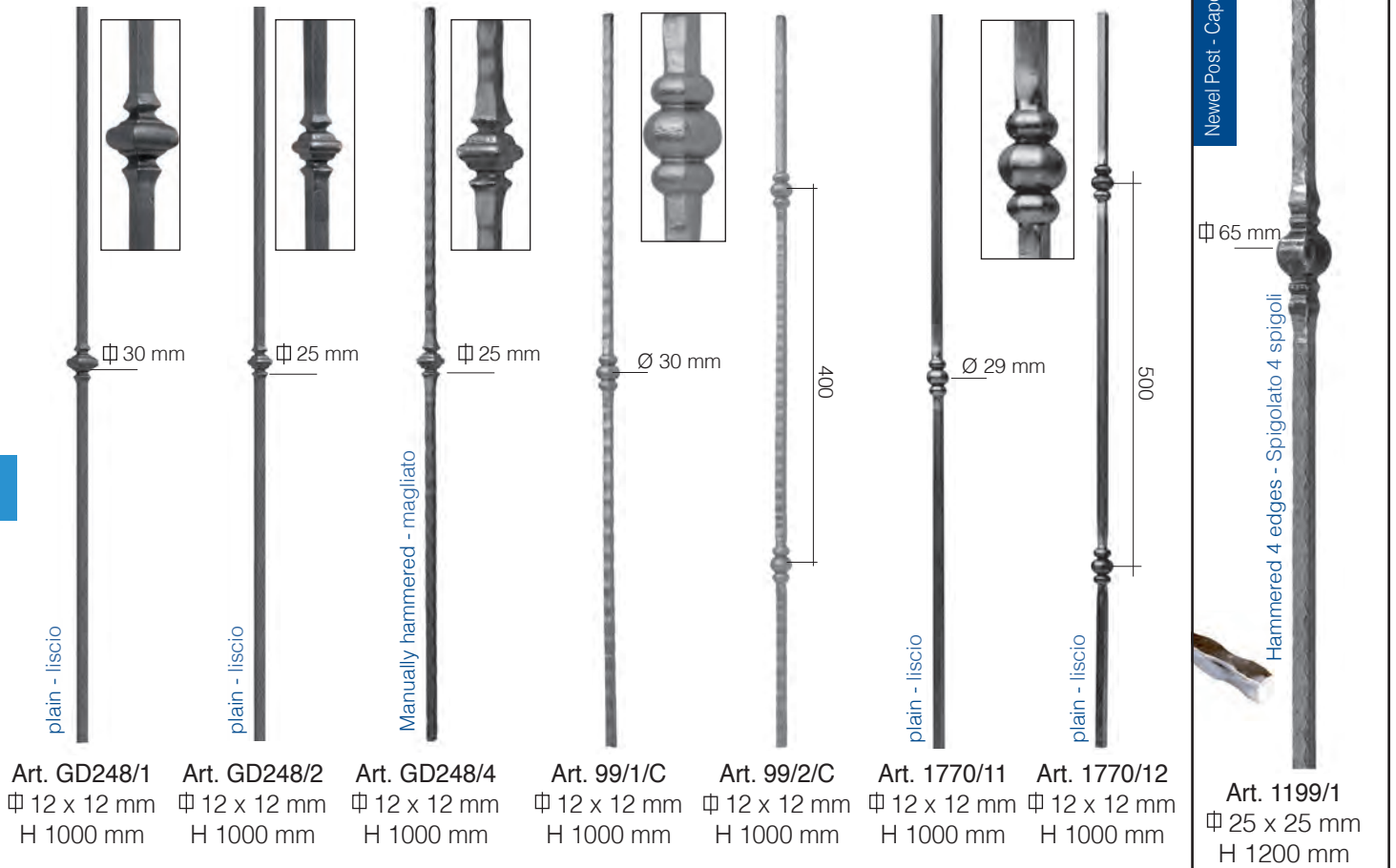

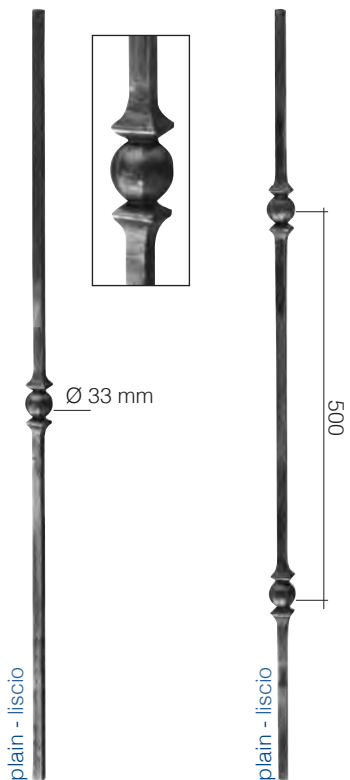

Art. 1770/15
Ø 12 x 12 mm
H 1000 mm
Art. 1770/16
Ø 14 x 14 mm
H 1000 mm

Art. 1770/13
Ø 12 x 12 mm
H 1000 mm
Art. 1770/14
Ø 14 x 14 mm
H 1000 mm

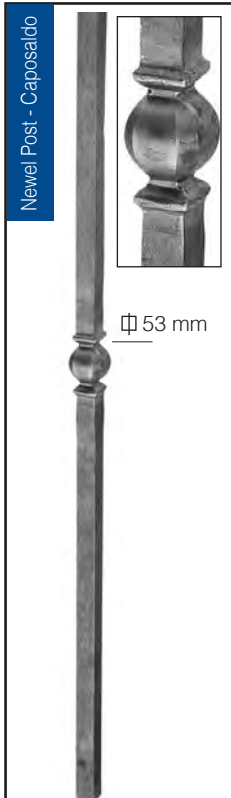

Art. 1769/7
Ø 25 x 25 mm
H 1200 mm
Art. 1769/8
Ø 30 x 30 mm
H 1200 mm

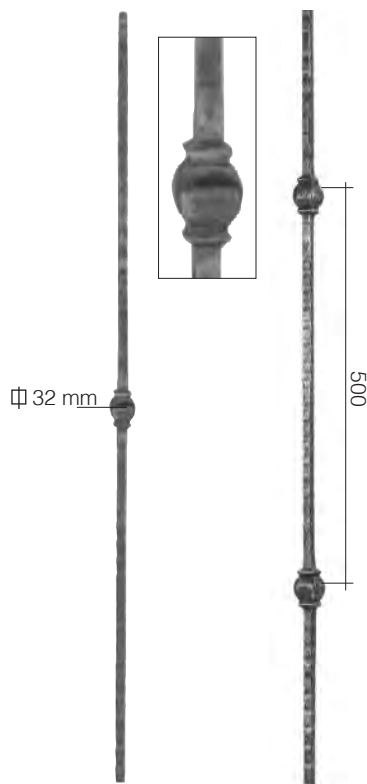

Art. 1770/8
Ø 12 x 12 mm
H 1000 mm

Art. 1771/8
Ø 12 x 12 mm
H 1000 mm



Art. 1199/2
Ø 25 x 25 mm
H 1200 mm

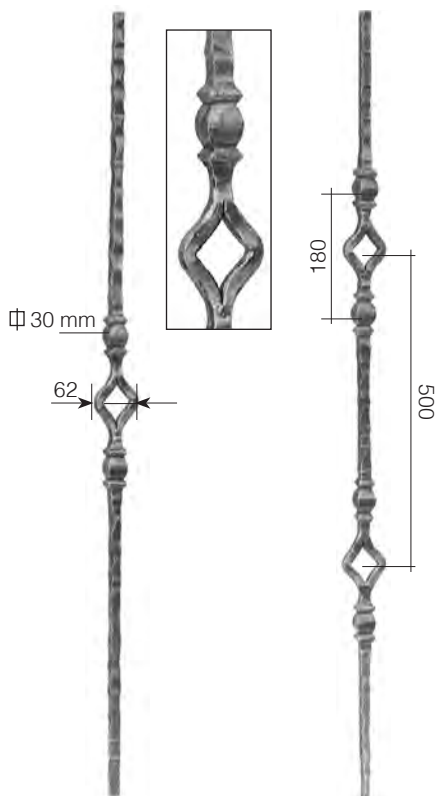

Art. 507/1
Ø 14 x 14 mm
H 1000 mm

Art. 507/2
Ø 14 x 14 mm
H 1000 mm



Art. 112/5
Ø 25 x 25 mm
H 1200 mm
Art. 112/6
Ø 30 x 30 mm
H 1200 mm
Art. 799/3
Ø 40 x 40 mm
H 1200 mm



Art. 98/1
H 1000 mm



Art. 493/2
H 1000 mm

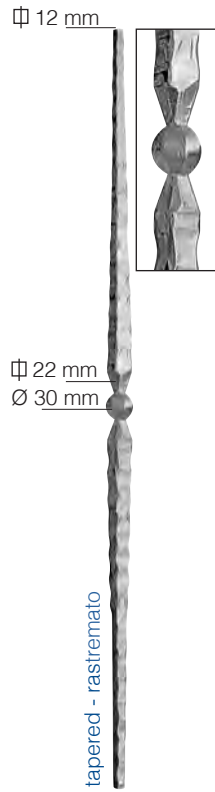

Art. 109/3
H 1000 mm

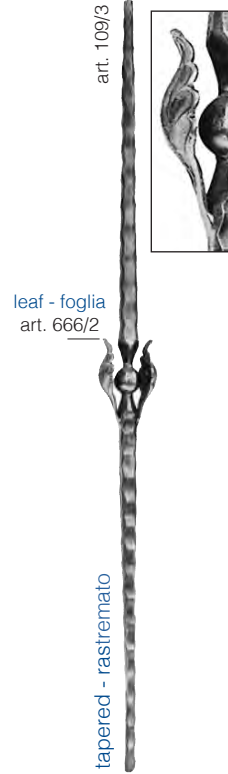

Art. 493/1
H 1000 mm



Manually
hammered
square bar to
match with posts

Quadro magliato
manualmente
per abbinamento
caposaldi

Art. 1370/11
25 x 25 mm
L 2000 mm

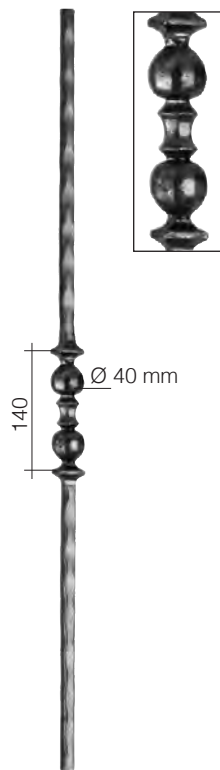

Art. 1770/5
14 x 14 mm
H 1000 mm

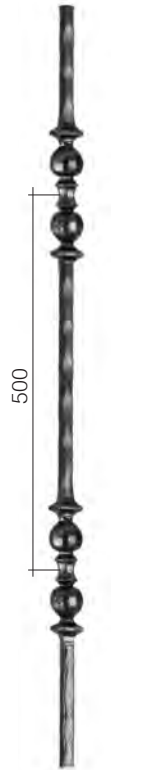

Art. 1771/5
14 x 14 mm
H 1000 mm

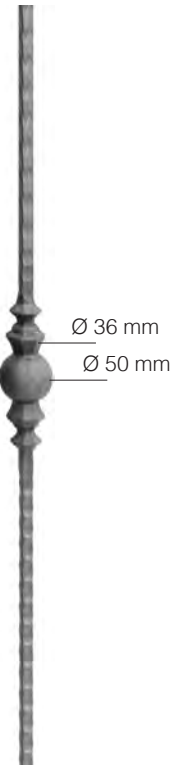

Art. 502/1
14 x 14 mm
H 1000 mm

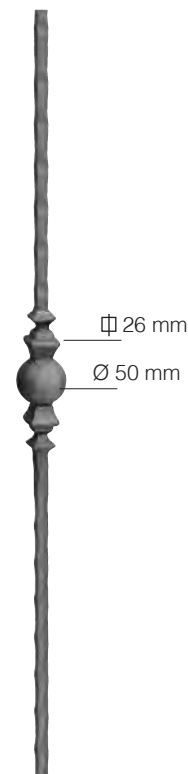

Art. 502/2
14 x 14 mm
H 900 mm



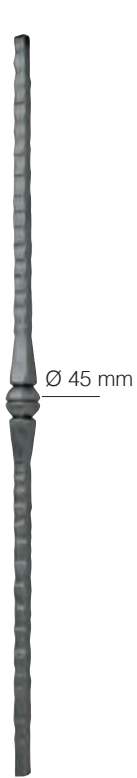

Art. 508/2
Ø 18 x 18 mm
H 900 mm



Art. 1769/4
Ø 12 x 12 mm
H 1000 mm



Art. 105/5/C
Ø 12 x 12 mm
H 1000 mm
Art. 105/3
Ø 14 x 14 mm
H 1000 mm



Art. 105/5
H 1000 mm
Ø 12 x 12 mm



Art. 118/B/1
Ø 12 x 12 mm
H 900 mm

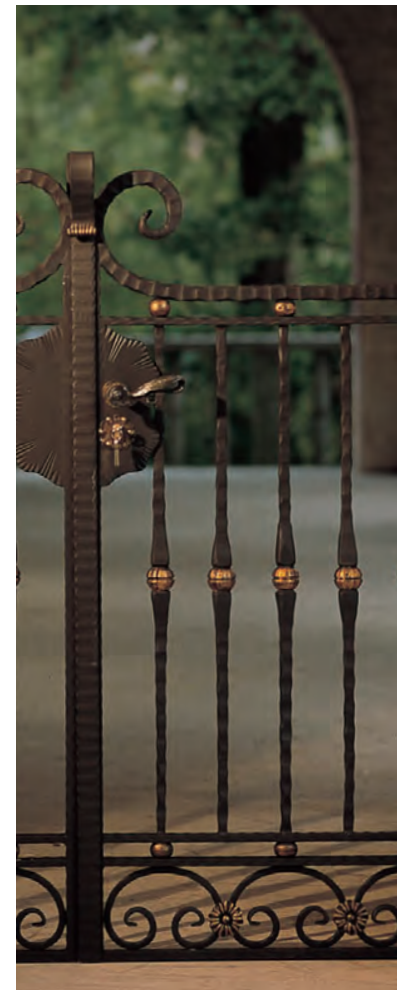

Art. 1185/1
Ø 12 x 12 mm
H 1000 mm



Art. 1189/1
Ø 12 x 12 mm
H 900 mm

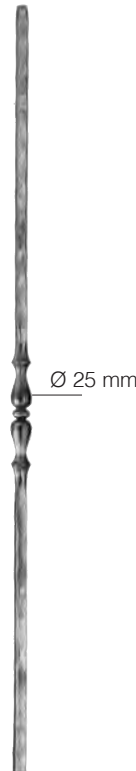

Art. 1770/6
Ø 12 x 12 mm
H 1000 mm



Art. 112/10
Ø 30 x 30 mm
H 1200 mm

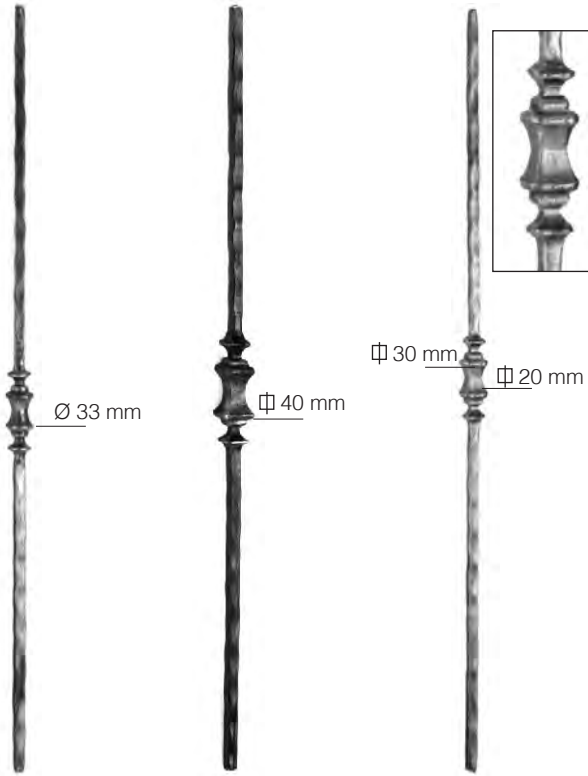

Art. 110/5
Ø 12 x 12 mm
H 1000 mm

Art. 110/4
Ø 14 x 14 mm
H 1000 mm

Art. 110/3
Ø 12 x 12 mm
H 1000 mm

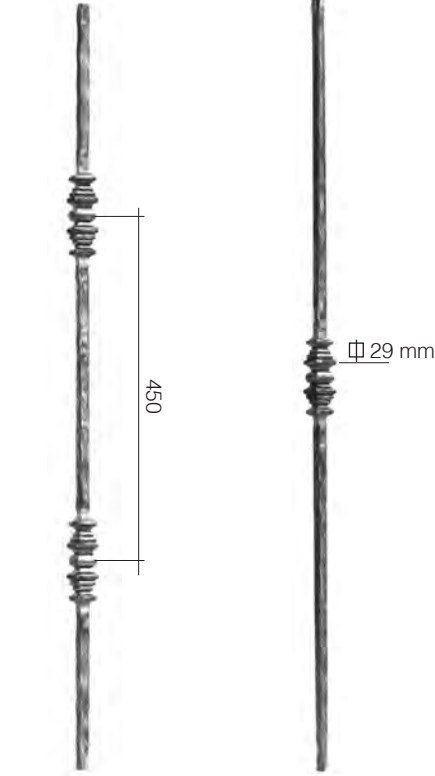

Art. 108/A/1
Ø 12 x 12 mm
H 1000 mm

Art. 108/A/2
Ø 12 x 12 mm
H 1000 mm



Art. 112/11
Ø 25 x 25 mm
H 1200 mm



Art. 1773/6
Ø 12 x 12 mm
H 1000 mm

Art. 1773/2
Ø 14 x 14 mm
H 1000 mm

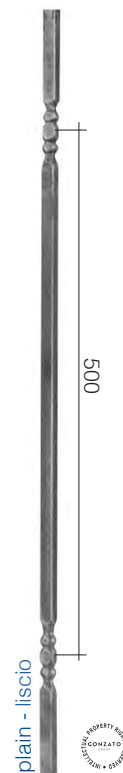

Art. 1773/5
Ø 12 x 12 mm
H 1000 mm

Art. 1773/1
Ø 14 x 14 mm
H 1000 mm

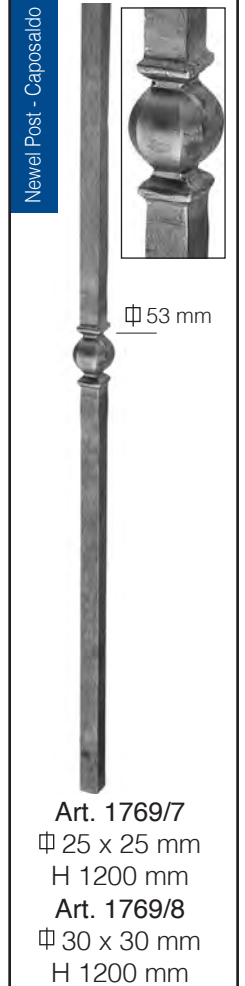

Art. 1769/7
Ø 25 x 25 mm
H 1200 mm
Art. 1769/8
Ø 30 x 30 mm
H 1200 mm

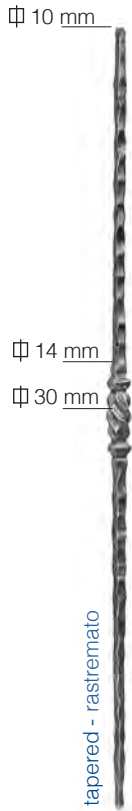

Art. 505/3
Ø 14 x 14 mm
H 1000 mm

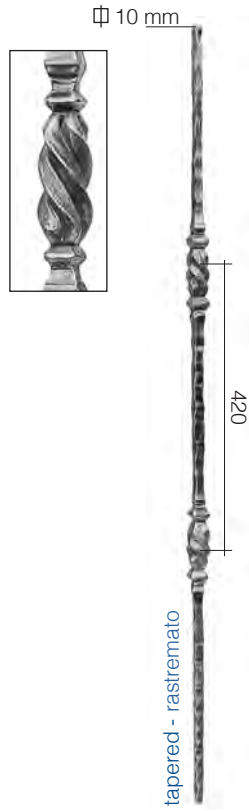

Art. 505/4
Ø 14 x 14 mm
H 1000 mm

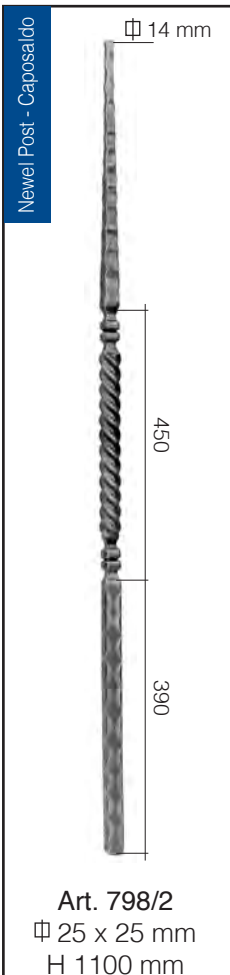

Art. 798/2
Ø 25 x 25 mm
H 1100 mm

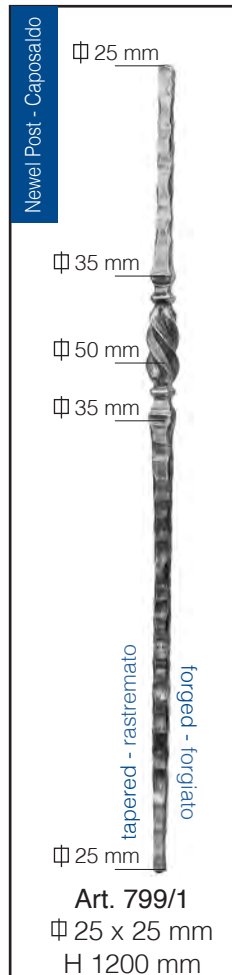

Art. 799/1
Ø 25 x 25 mm
H 1200 mm



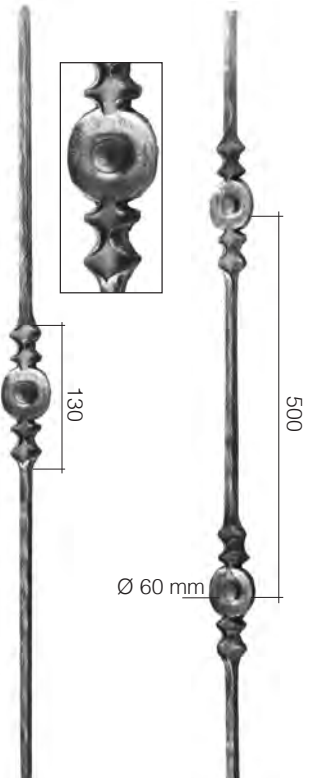

Art. 104/3
Ø 12 x 12 mm
H 1000 mm

Art. 104/4
Ø 12 x 12 mm
H 1000 mm



Art. 1192/1
Ø 16 x 8 mm
H 1000 mm

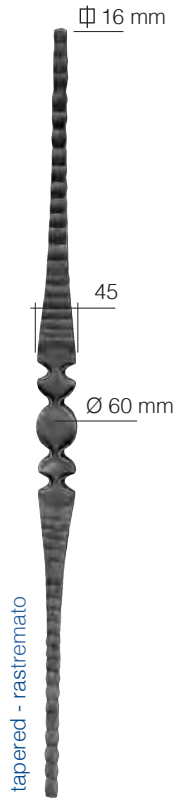

Art. 1192/2
Ø 16 x 8 mm
H 1000 mm



Art. 1192/3
Ø 12 x 10 mm
H 1000 mm

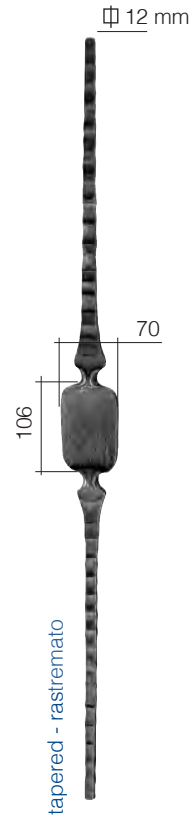

Art. 1192/4
Ø 12 x 10 mm
H 1000 mm



Newel Post - Caposaldo

Art. 112/7
Ø 25 x 25 mm
H 1200 mm
Art. 112/8
Ø 30 x 30 mm
H 1200 mm

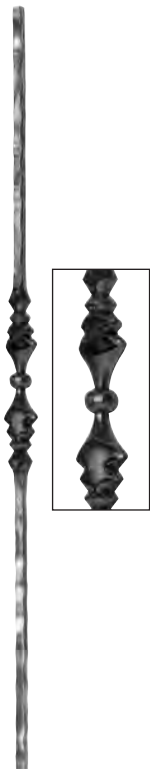

Art. 496/B/1
Ø 13 x 13 mm
H 1000 mm



Art. 496/B/2
Ø 13 x 13 mm
H 1000 mm



Art. 496/B/3
Ø 13 x 13 mm
H 1000 mm

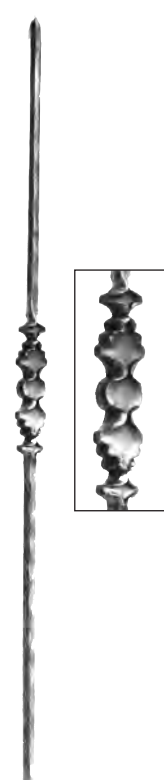

Art. 106/2
Ø 12 x 12 mm
H 1000 mm

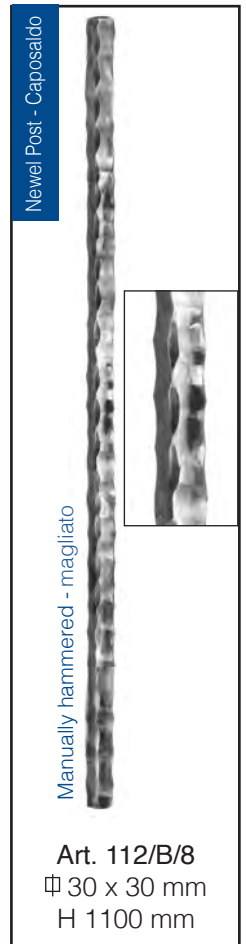

Newel Post - Caposaldo

Manually hammered - magliato

Art. 112/B/8
Ø 30 x 30 mm
H 1100 mm

matchable with forged pickets Ø 12 mm
abbinabili ai paletti forgiati Ø 12 mm



Art. 1185/4
Ø 12 mm
H 1000 mm

Forged - Magliato



Art. 1185/5
Ø 14 mm
H 1000 mm



Art. 1187/2
Conico/Conic
H 1000 mm



Art. 1184/6
Ø 12 mm
H 1000 mm



Art. 496/C/3/C
Conico/Conic
H 1000 mm



Art. 1256/5
Ø 25 mm
H 900 mm

Newel Post - Caposaldo





Art. 1199/3
Ø 26 mm
H 1200 mm

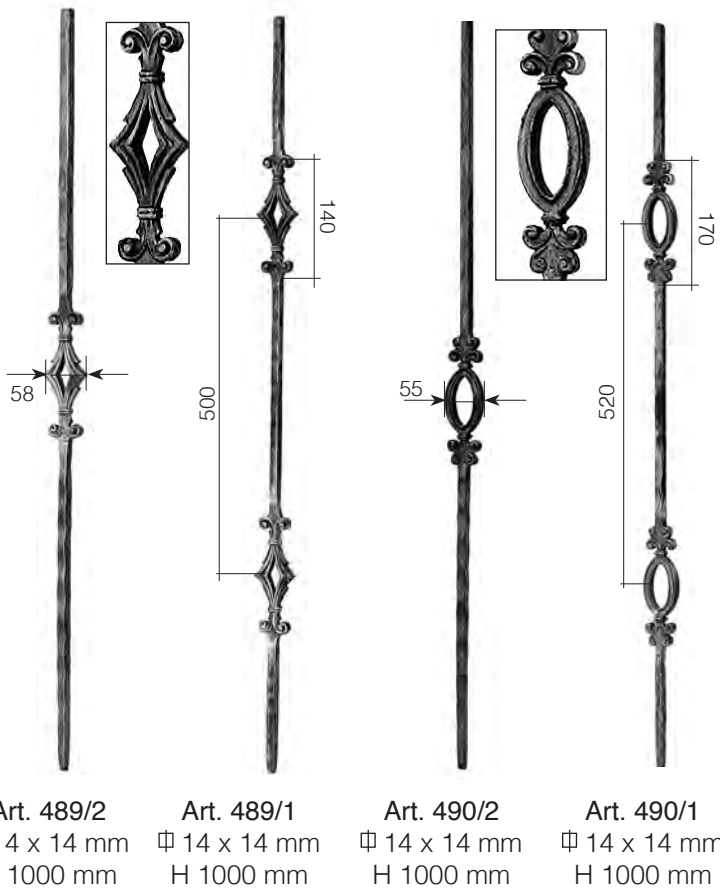
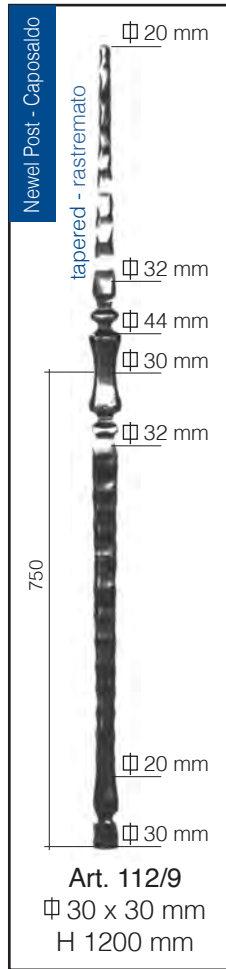
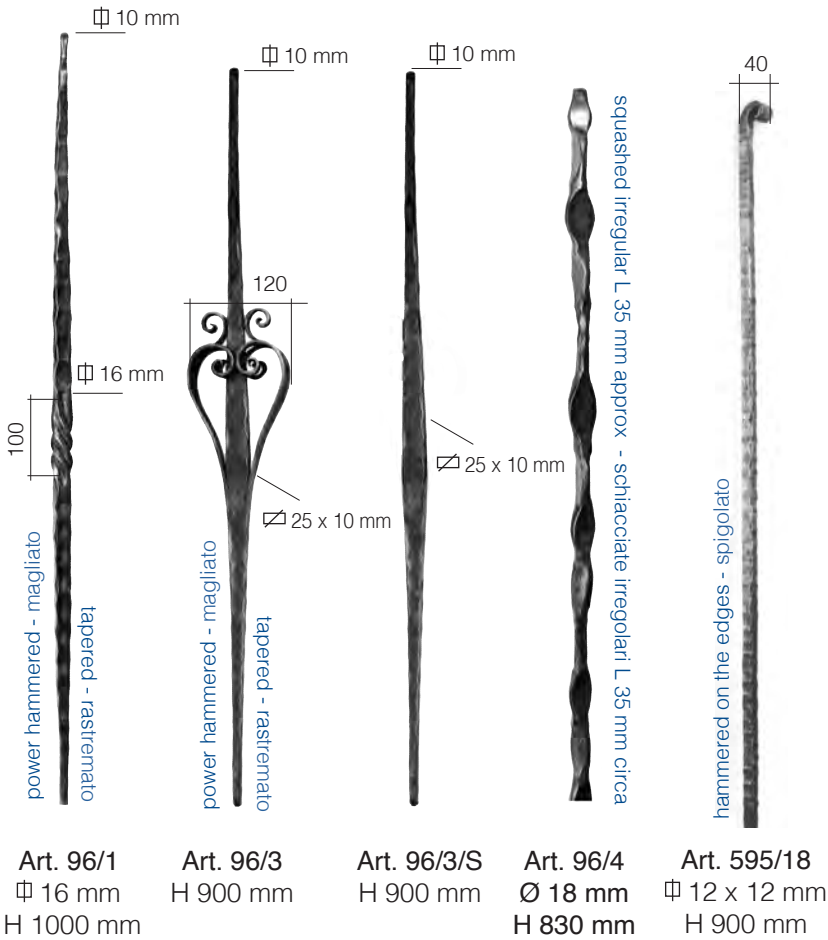



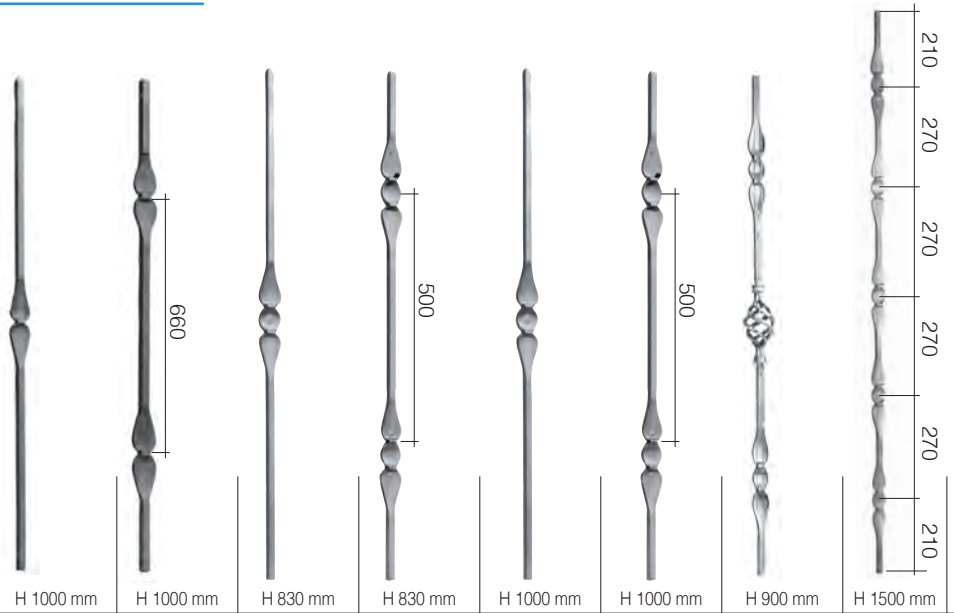











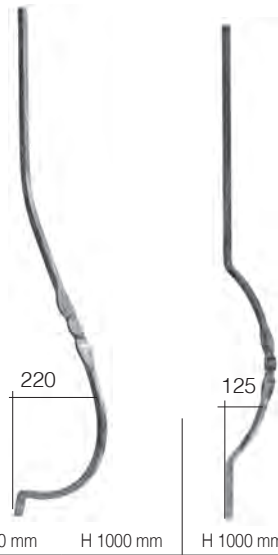



| Sec.Sez. | Finish - Finitura | Art | Art | Art. | Art. | Art. | Art. | Art. | Art. |
|-----------|--|-------|--------|--------|--------|---------|---------|-------|----------|
| Ø 12 mm | Plain - Liscio  | 134/6 | 134/14 | 134/1 | - | 134/2 | 134/10 | 585/1 | 134/A/14 |
| | Stamped on plain edge Stampato sullo spigolo liscio  | - | - | - | - | 1749/11 | 1749/9 | - | - |
| | Hammered - Spigolato  | - | - | 587/41 | 587/45 | 587/42 | 587/46 | - | - |
| 12 x 6 mm | Plain - Liscio  | - | - | - | - | - | - | - | 134/A/12 |
| Ø 12 mm | Plain - Liscio  | - | - | - | - | 1251/9 | 1251/10 | - | - |
| Ø 14 mm | Plain - Liscio  | - | - | - | - | 134/4 | 134/12 | - | - |
| | Stamped on plain edge Stampato sullo spigolo liscio  | - | - | - | - | 1749/12 | 1749/10 | - | - |
| | Hammered - Spigolato  | - | - | - | - | 587/44 | 587/48 | - | - |
| | Bark effect - Corteccia  | - | - | - | - | 1251/3 | 1251/4 | - | - |
| | Four-leaf clover - Quadrifoglio  | - | - | - | - | 1251/7 | 1251/8 | - | - |
| Ø 14 mm | Plain - Liscio  | - | - | - | - | 1251/11 | 1251/12 | - | - |

Arteferro products can be manufactured as well as customised.

I prodotti Arteferro sono realizzabili anche su misura.







| Sec.Sez. | Finish - Finitura | Art. | Art. | Art. |
|-------------|--|--------|--------|--------|
| ∅ 12 mm | Plain - Liscio  | 586/14 | 586/6 | 586/8 |
| | Stamped on plain edge Stampato sullo spigolo liscio  | - | - | - |
| | Hammered - Spigolato  | - | - | - |
| ∇ 12 x 6 mm | Plain - Liscio  | - | - | - |
| ∅ 12 mm | Plain - Liscio  | - | 586/12 | 586/10 |
| ∅ 14 mm | Plain - Liscio  | 586/15 | 586/7 | 586/9 |
| | Stamped on plain edge Stampato sullo spigolo liscio  | - | - | - |
| | Hammered - Spigolato  | - | - | - |
| | Bark effect - Corteccia  | - | - | - |
| ∅ 14 mm | Four-leaf clover - Quadrifoglio  | - | - | - |
| | Plain - Liscio  | - | 586/13 | 586/11 |



Newel Post - Caposaldo



| Sec.Sez. | Finish - Finitura | Art. |
|----------|--|---------|
| ∅ 25 mm | Plain Liscio  | 1775/11 |
| ∅ 25 mm | Plain Liscio  | 1775/6 |
| ∅ 30 mm | Plain Liscio  | 1775/12 |





Newel Post - Caposaldo



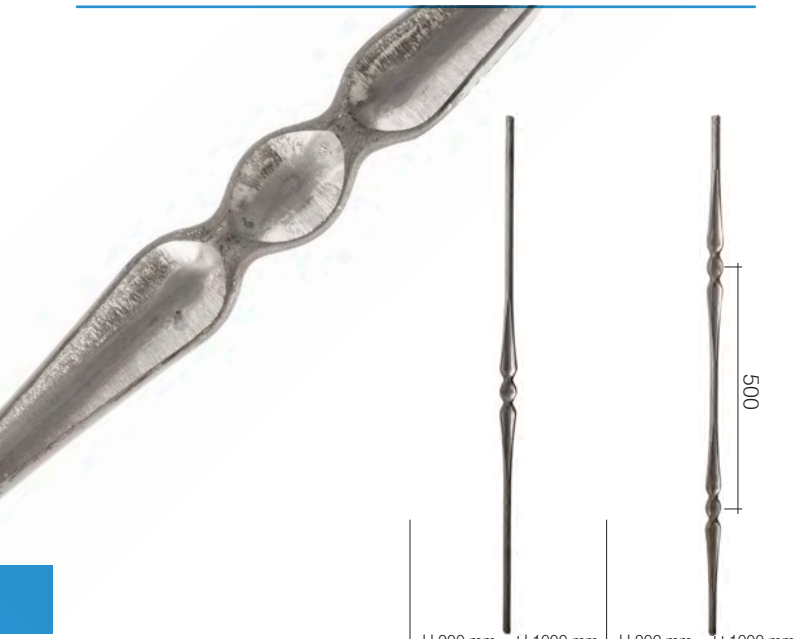

| Sec.Sez. | Finish - Finitura | Art. |
|----------|--|--------|
| ∅ 25 mm | Plain Liscio  | 1775/4 |
| ∅ 25 mm | Plain Liscio  | 1775/1 |
| ∅ 30 mm | Plain Liscio  | 1775/2 |





| Sec.Sez. | Finish - Finitura | Art. | Art. | Art. | Art. |
|----------|--|--------|--------|--------|--------|
| ∅ 12 mm | Plain Liscio  | - | 1749/1 | - | 1749/3 |
| ∅ 14 mm | Plain Liscio  | - | 1749/2 | - | 1749/4 |
| ∅ 14 mm | Hammered Spigolato  | - | - | 64/L/1 | - |
| ∅ 14 mm | Plain Liscio  | 64/L/4 | - | 64/L/3 | - |





| Sec.Sez. | Finish - Finitura | Art. | Art. | Art. |
|----------|--|--------|--------|--------|
| ∅ 12 mm | Plain Liscio  | 1721/1 | 1721/3 | - |
| ∅ 14 mm | Plain Liscio  | - | - | 1721/6 |



Newel Post - Caposaldo

H 1200 mm

| Sec.Sez. | Finish - Finitura | Art. |
|----------|--|--------|
| ∅ 20 mm | Plain Liscio  | 1775/3 |
| ∅ 25 mm | Plain Liscio  | 1775/4 |

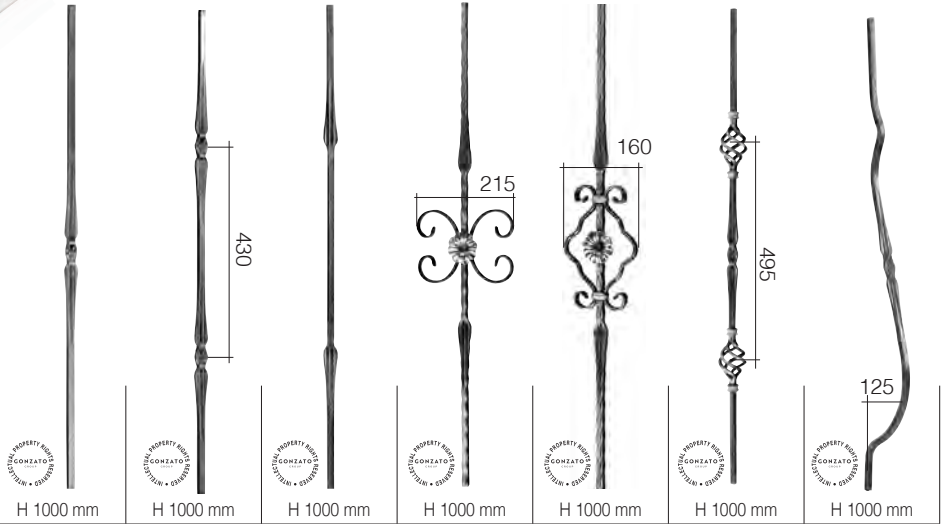

| Sec.Sez. | Finish - Finitura | | Art. | Art. | Art. | Art. | Art. | Art. | Art. |
|----------|------------------------|--|--------|--------|--------|--------|---------|--------|---------|
| ∅ 12 mm | Plain Liscio | | 1705/1 | 1705/3 | 1705/5 | - | - | 1733/3 | 1705/13 |
| | Hammered Spigolato | | 1707/1 | 1707/3 | 1707/5 | - | - | - | 1780/1 |
| | Bark effect Cortecchia | | 1710/1 | 1710/2 | 1710/5 | - | - | - | - |
| ∅ 12 mm | Plain Liscio | | 1716/1 | 1716/3 | - | - | - | - | - |
| ∅ 14 mm | Plain Liscio | | 1705/2 | 1705/4 | - | - | - | - | - |
| | Hammered Spigolato | | 1707/2 | 1707/4 | - | - | - | - | - |
| | Bark effect Cortecchia | | 1710/3 | 1710/4 | 1710/6 | 1710/8 | - | - | - |
| ∅ 14 mm | Plain Liscio | | 1716/2 | 1716/4 | - | - | 1716/10 | - | - |



Newel Post - Caposaldo

| Sec.Sez. | Finish - Finitura | | Art. |
|----------|------------------------|--|---------|
| ∅ 25 mm | Plain Liscio | | 1705/15 |
| | Hammered Spigolato | | 1777/9 |
| | Bark effect Cortecchia | | 1777/4 |
| ∅ 25 mm | Plain Liscio | | 1777/1 |

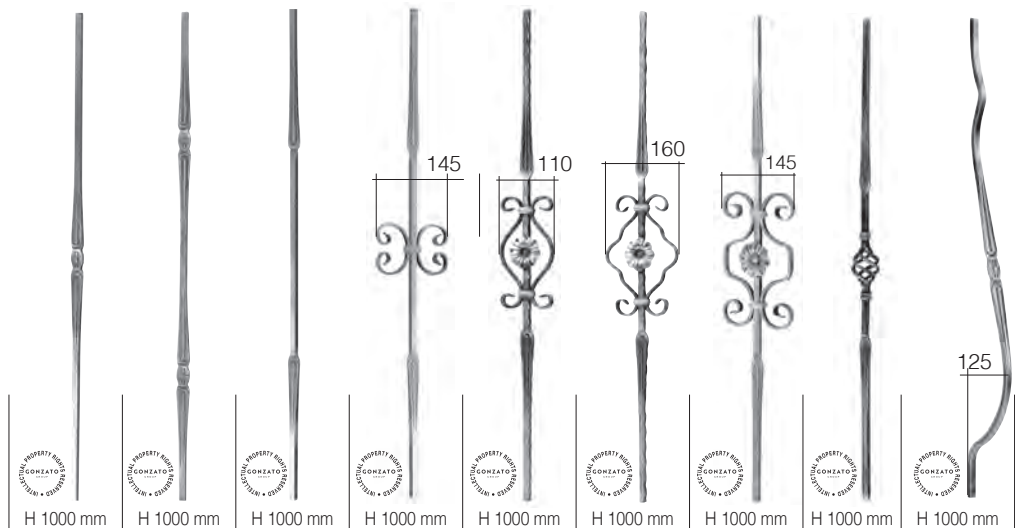

| Sec.Sez. | Finish - Finitura | | Art. | Art. | Art. | Art. | Art. | Art. | Art. | Art. | Art. |
|----------|------------------------|--|---------|---------|---------|--------|---------|---------|---------|---------|---------|
| ∅ 12 mm | Plain Liscio | | 1701/1 | 1701/3 | 1701/5 | 1701/7 | - | - | 1701/11 | 1733/9 | 1701/13 |
| | Hammered Spigolato | | 1709/1 | 1709/3 | 1709/5 | - | 1709/9 | 1709/11 | - | - | 1780/5 |
| | Bark effect Cortecchia | | 1710/13 | 1710/5 | - | - | 1710/21 | 1710/23 | - | - | 1780/13 |
| ∅ 12 mm | Plain Liscio | | 1716/13 | 1716/15 | - | - | - | 1716/21 | - | - | 1779/13 |
| ∅ 14 mm | Plain Liscio | | 1701/2 | 1701/4 | 1701/6 | - | - | - | 1701/12 | 1733/10 | 1701/14 |
| | Hammered Spigolato | | 1709/2 | 1709/4 | 1709/6 | - | 1709/10 | 1709/12 | - | - | 1780/6 |
| | Bark effect Cortecchia | | 1710/14 | 1710/16 | 1710/18 | - | 1710/22 | 1710/24 | | | 1780/14 |
| ∅ 14 mm | Plain Liscio | | 1716/14 | 1716/16 | 1716/18 | - | - | 1716/22 | | | 1779/14 |



Newel Post - Caposaldo

| Sec.Sez. | Finish - Finitura | | Art. |
|----------|------------------------|--|---------|
| ∅ 25 mm | Plain Liscio | | 1701/15 |
| | Hammered Spigolato | | 1777/7 |
| | Bark effect Cortecchia | | 1777/6 |
| ∅ 25 mm | Plain Liscio | | 1777/2 |

H 1200 mm



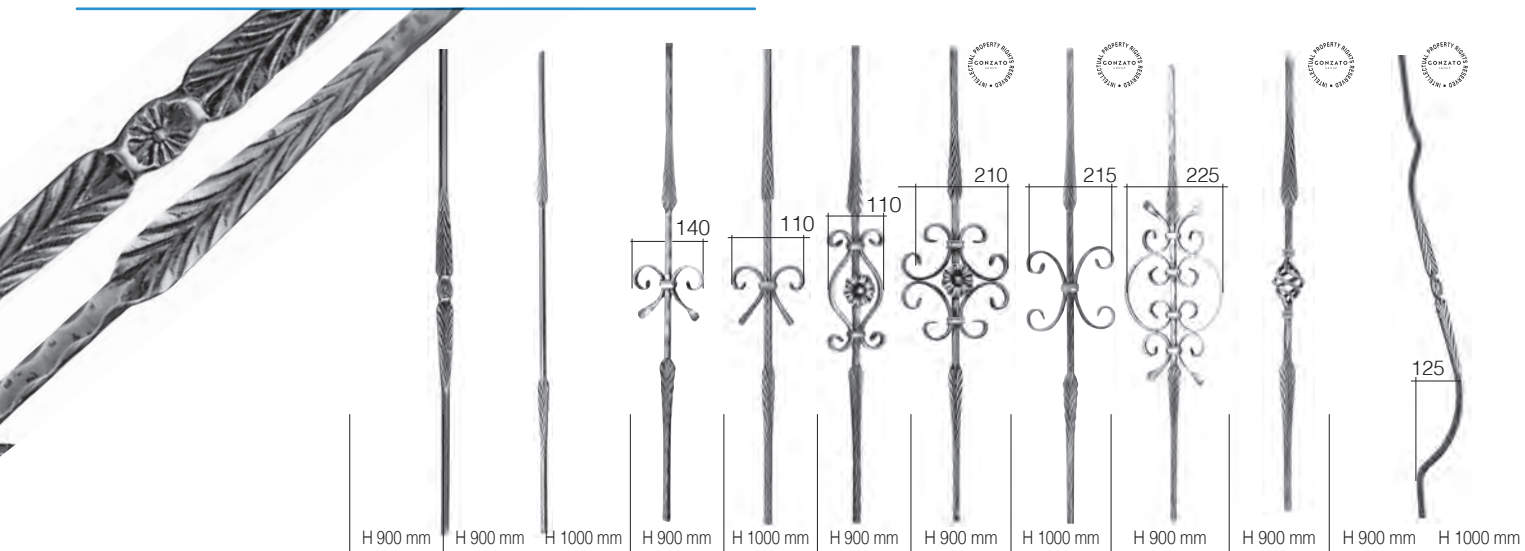

| Sec.Sez. | Finish - Finitura | Art. | Art. | Art. | Art. | Art. | Art. | Art. | Art. | Art. | Art. | Art. | Art. |
|----------|--------------------|--------|--------|--------|--------|--------|--------|-------|-------|--------|-------|---------|-----------|
| Ø 12 mm | Plain Liscio | - | - | - | - | - | - | - | - | - | - | - | - |
| | Hammered Spigolato | 64/F/2 | 64/F/4 | - | 64/F/6 | - | 64/F/8 | 561/5 | 561/3 | 64/G/1 | 562/1 | 64/H/9 | 64/H/9/S |
| | Diamond Diamantato | - | - | 1137/3 | - | 1138/3 | - | - | - | - | - | - | 1137/7 |
| Ø 14 mm | Plain Liscio | - | - | - | - | - | - | - | - | - | - | 572/1 | - |
| | Hammered Spigolato | 64/F/3 | 64/F/5 | - | 64/F/7 | - | 64/F/9 | 561/6 | 561/4 | 64/G/2 | 562/2 | 64/H/10 | 64/H/10/S |
| | Diamond Diamantato | - | - | 1137/4 | - | 1138/4 | - | - | - | - | - | - | 1137/8 |
| Ø 14 mm | Plain Liscio | 573/2 | 573/4 | 573/10 | - | - | - | - | - | - | - | 572/3 | - |

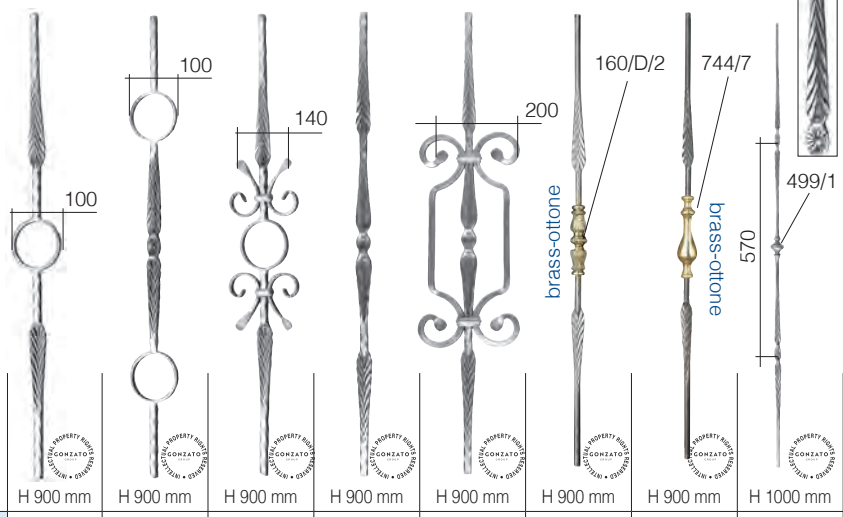

| Sec.Sez. | Finish - Finitura | Art. | Art. | Art. | Art. | Art. | Art. | Art. | Art. |
|----------|---------------------|-------|-------|-------|-------|-------|-------|-------|-------|
| Ø 12 mm | Hammered Spigolato | - | 563/1 | - | 571/1 | - | - | - | - |
| Ø 14 mm | Hammered Spigolato | 563/4 | 563/2 | 567/2 | 571/2 | 571/4 | - | - | - |
| Ø 12 mm | Power hamm Magliato | - | - | - | - | - | - | - | 504/1 |
| Ø 14 mm | Plain Liscio | - | - | - | - | - | 560/1 | 560/2 | - |

Newel Post - Caposaldo



hammered - spigolato

Art. 64/F/1
Ø 25 x 25 mm
H 1200 mm

Newel Post - Caposaldo



plain - liscio

Art. 801/1
Ø 25 mm
H 1200 mm

Art. 801/7
Ø 30 mm
H 1200 mm

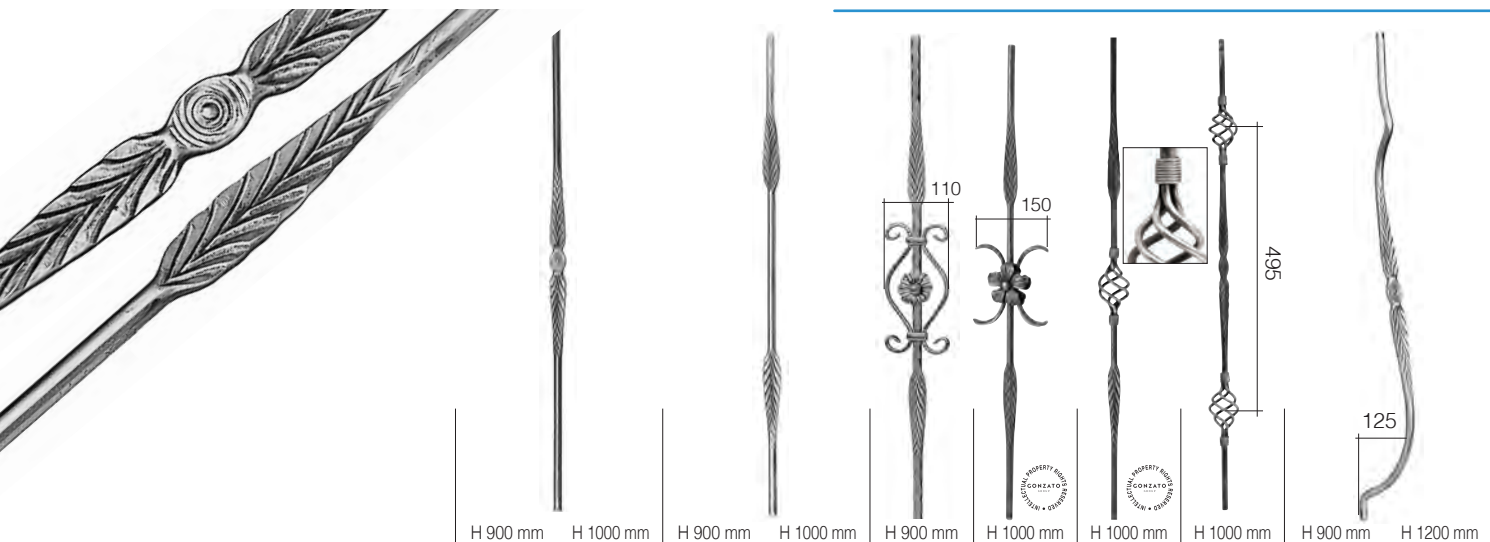

| Sec.Sez. | Finish - Finitura | Art. | Art. | Art. | Art. | Art. | Art. | Art. | Art. | Art. | Art. |
|----------|--------------------|-------|--------|-------|---------|-------|--------|--------|--------|--------|--------|
| Φ 12 mm | Plain Liscio | - | - | - | - | - | - | - | - | - | - |
| | Hammered Spigolato | 578/1 | 1136/5 | 578/3 | 1136/6 | 578/5 | - | - | - | 578/17 | 578/18 |
| | Diamond Diamantato | - | - | - | - | - | - | - | - | - | - |
| Ø 12 mm | Plain Liscio | 576/1 | 576/5 | 576/3 | 576/6 | - | - | 1734/1 | 1734/2 | 578/13 | 578/14 |
| Φ 14 mm | Plain Liscio | - | - | - | - | - | - | - | - | - | - |
| | Hammered Spigolato | 578/2 | 1136/9 | 578/4 | 1136/10 | 578/6 | - | - | - | 578/19 | 578/20 |
| | Diamond Diamantato | - | - | - | - | - | - | - | - | - | - |
| Ø 14 mm | Plain Liscio | 576/2 | 1135/3 | 576/4 | 1135/4 | - | 1135/2 | - | - | 578/15 | 578/16 |

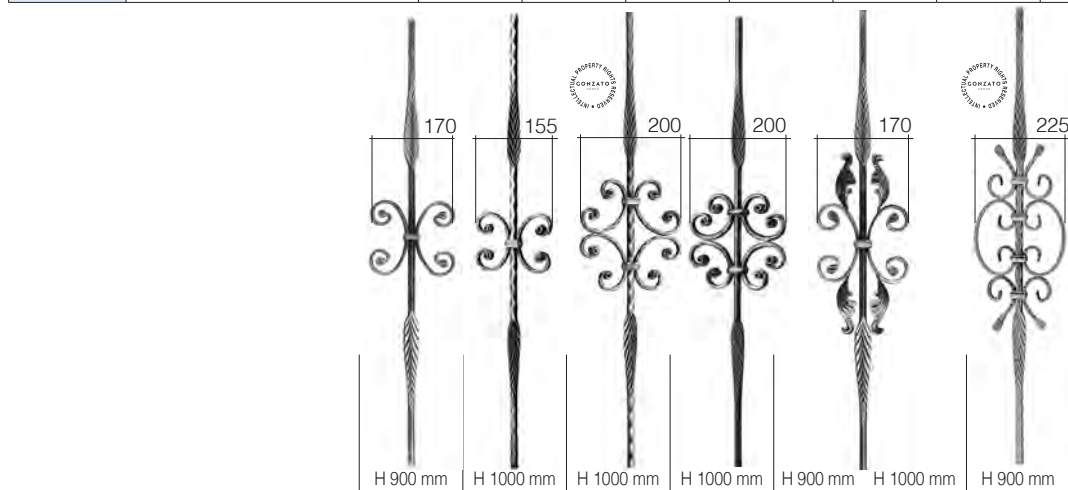

| Sec.Sez. | Finish - Finitura | Art. | Art. | Art. | Art. | Art. | Art. | Art. |
|----------|--------------------|-------|--------|--------|--------|-------|--------|--------|
| Φ 12 mm | Plain Liscio | - | - | - | - | - | - | - |
| | Hammered Spigolato | - | - | 1136/4 | - | - | - | 578/9 |
| | Diamond Diamantato | - | - | 1138/7 | - | - | - | - |
| Ø 12 mm | Plain Liscio | - | 1136/3 | - | - | 577/9 | 577/10 | - |
| Φ 14 mm | Plain Liscio | - | - | - | - | - | - | - |
| | Hammered Spigolato | - | - | 1136/8 | - | - | - | 578/10 |
| | Diamond Diamantato | - | - | 1138/8 | - | - | - | - |
| Ø 14 mm | Plain Liscio | 577/3 | 1136/7 | - | 1136/2 | 577/2 | 577/5 | - |

Newel Posti - Caposaldo

hammered - spigolato

Art. 801/2
Φ 25 x 25 mm
H 1200 mm







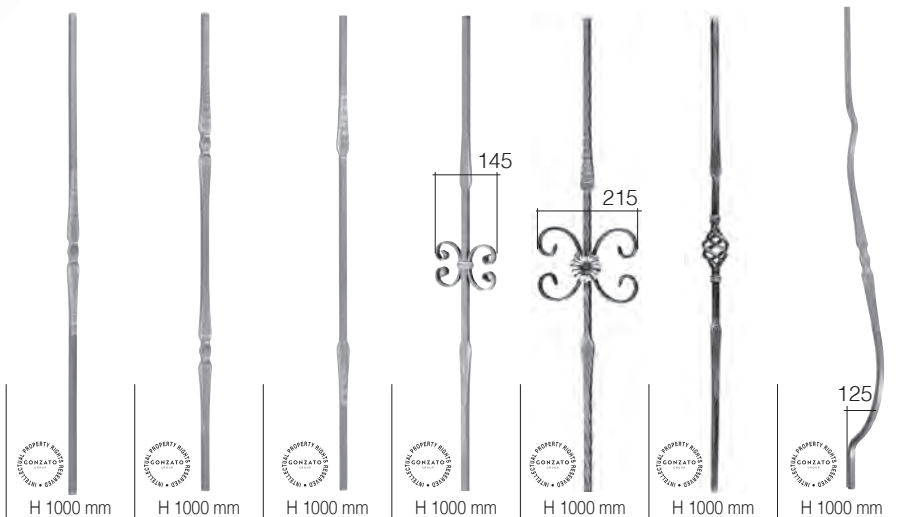
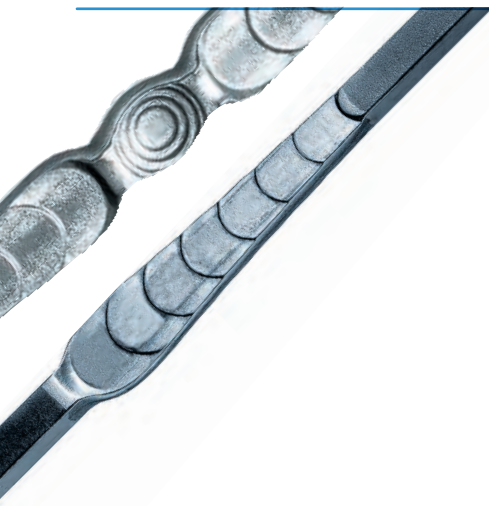

Newel Posti - Caposaldo

plain - liscio

Art. 801/5
Ø 25 mm
H 1200 mm

Art. 801/8
Ø 30 mm
H 1200 mm







| Sezione | Finish - Finitura | Art. | Art. | Art. | Art. | Art. | Art. | Art. |
|---------|--|---------|---------|---------|--------|---------|--------|---------|
| Φ 12 mm | Plain Liscio  | 1702/1 | 1702/3 | 1702/5 | 1702/7 | - | 1733/5 | 1702/13 |
| | Hammered Spigolato  | 1709/13 | 1709/15 | 1709/17 | - | 1709/19 | - | 1780/3 |
| | Bark effect Cortecchia  | 1713/1 | 1713/3 | 1713/5 | - | 1713/7 | - | 1780/11 |
| Ø 12 mm | Plain Liscio  | 1714/1 | 1714/3 | 1714/5 | - | - | - | 1779/11 |
| Φ 14 mm | Plain Liscio  | 1702/2 | 1702/4 | 1702/6 | 1702/8 | - | 1733/6 | 1702/14 |
| | Hammered Spigolato  | 1709/14 | 1709/16 | 1709/18 | - | 1709/20 | - | 1780/4 |
| | Bark effect Cortecchia  | 1713/2 | 1713/4 | 1713/6 | - | 1713/8 | - | 1780/12 |
| Ø 14 mm | Plain Liscio  | 1714/2 | 1714/4 | 1714/6 | - | - | - | 1779/12 |

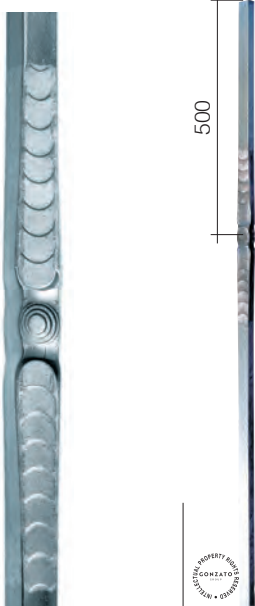

Newel Post - Caposaldo



H 1200 mm

| Sezione | Finish - Finitura | Art. |
|---------|--|---------|
| Φ 25 mm | Plain Liscio  | 1702/15 |
| | Hammered Spigolato  | 1777/8 |
| | Bark effect Cortecchia  | 1777/5 |
| Ø 25 mm | Plain Liscio  | 1777/3 |

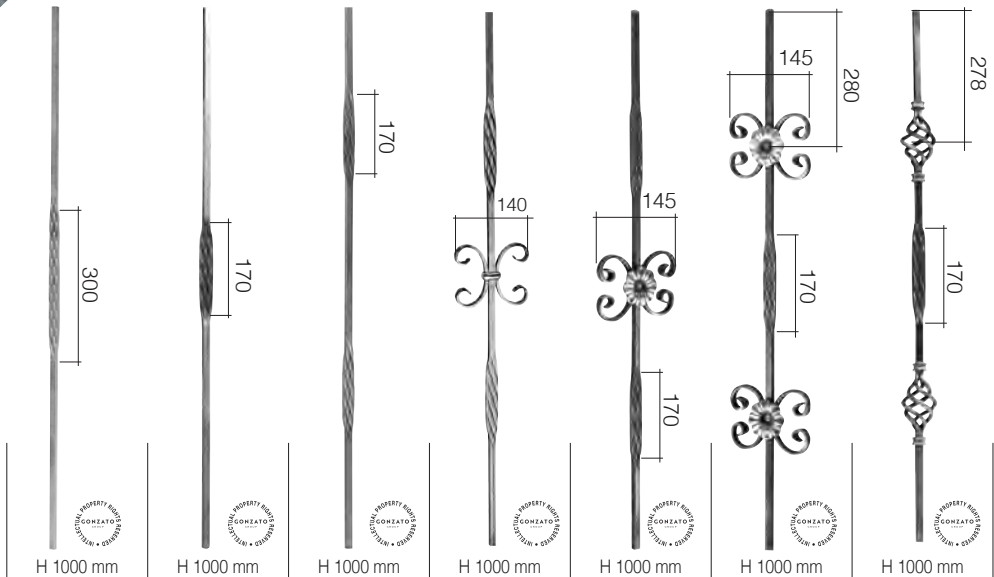
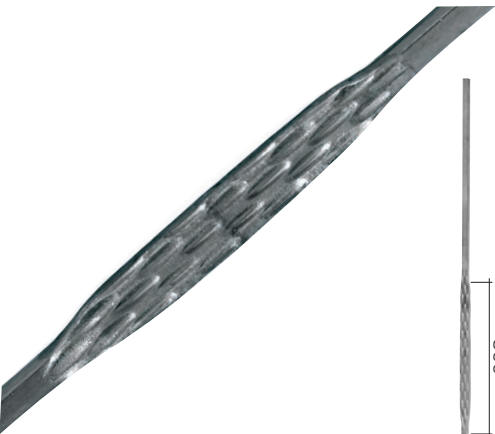

| Sec.Sez. | Finish - Finitura | Art. | Art. | Art. | Art. | Art. | Art. | Art. |
|----------|-------------------|--------|---------|--------|--------|--------|--------|--------|
| 12 mm | Plain Liscio | 1727/1 | 1729/11 | 1727/3 | 1727/5 | 1729/7 | 1729/5 | 1729/1 |
| Φ 14 mm | Plain Liscio | 1727/2 | 1729/12 | 1727/4 | 1727/6 | 1729/8 | 1729/6 | 1729/2 |

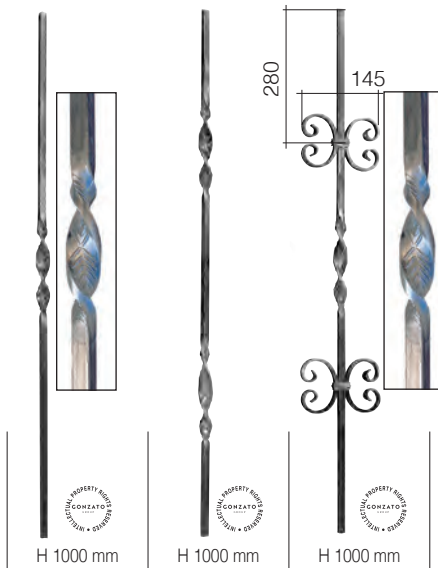

| Sec.Sez. | Finish - Finitura | Art. | Art. | Art. |
|----------|-------------------|---------|---------|---------|
| Φ 12 mm | Plain Liscio | 1730/11 | 1730/9 | 1730/13 |
| Φ 14 mm | Plain Liscio | 1730/12 | 1730/10 | - |

Newel Post - Caposaldo

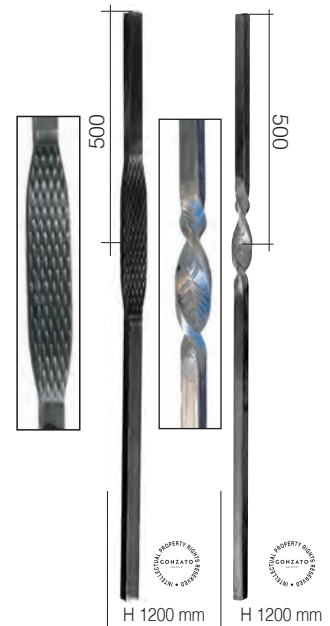

| Sec.Sez. | Finish - Finitura | Art. | Art. |
|----------|-------------------|--------|---------|
| Φ 20 mm | Plain Liscio | 1775/7 | - |
| Φ 25 mm | Plain Liscio | 1775/8 | 1730/17 |
| Φ 30 mm | Plain Liscio | 1777/9 | - |

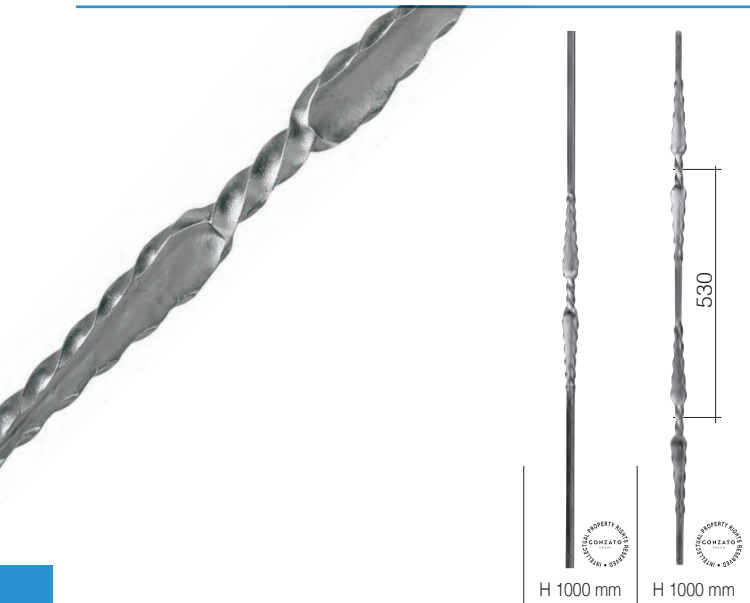

| Sec.Sez. | Finish - Finitura | Art. | Art. |
|----------|-------------------|--------|--------|
| ∅ 12 mm | Plain Liscio | 1730/3 | 1730/1 |
| ∅ 14 mm | Plain Liscio | 1730/4 | 1730/2 |



| Sec.Sez. | Finish - Finitura | Art. | Art. |
|----------|-------------------|--------|--------|
| ∅ 12 mm | Plain Liscio | 1730/7 | - |
| ∅ 14 mm | Plain Liscio | 1730/8 | 1730/6 |



| Sec.Sez. | Finish - Finitura | Art. | Art. | Art. | Art. |
|----------|-------------------|-------|-------|-------|-------|
| ∅ 12 mm | Plain Liscio | 50/5 | 50/6 | 50/7 | 50/8 |
| ∅ 14 mm | Plain Liscio | 50/9 | 50/10 | 50/11 | 50/12 |
| ∅ 16 mm | Plain Liscio | 50/13 | 50/14 | 50/15 | 50/16 |



| Sec.Sez. | Finish - Finitura | Art. |
|----------|-------------------|-------|
| ∅ 20 mm | Plain Liscio | 113/5 |
| ∅ 30 mm | Plain Liscio | 113/6 |

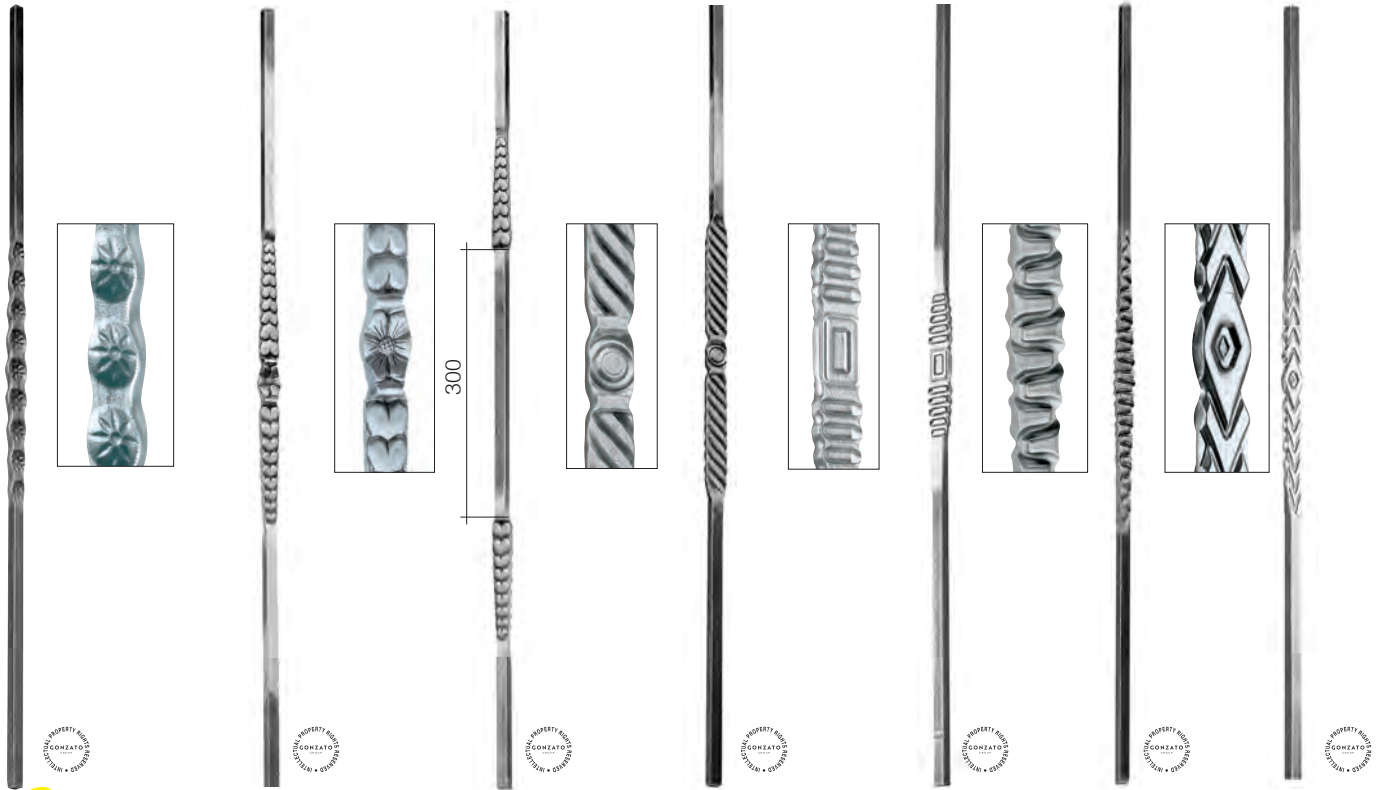

Art. 1718/9

Ø 12 mm
H 1000 mm
Art. 1718/10
Ø 14 mm
H 1000 mm

Art. 1718/13

Ø 12 mm
H 1000 mm
Art. 1718/14
Ø 14 mm
H 1000 mm

Art. 1718/16

Ø 14 mm
H 1000 mm

Art. 1718/3

Ø 12 mm
H 1000 mm

Art. 1718/5

Ø 12 mm
H 1000 mm
Art. 1718/6
Ø 14 mm
H 1000 mm

Art. 1718/1

Ø 12 mm
H 1000 mm
Art. 1718/2
Ø 14 mm
H 1000 mm

Art. 1718/7

Ø 12 mm
H 1000 mm
Art. 1718/8
Ø 14 mm
H 1000 mm



Newel Post - Caposaldo

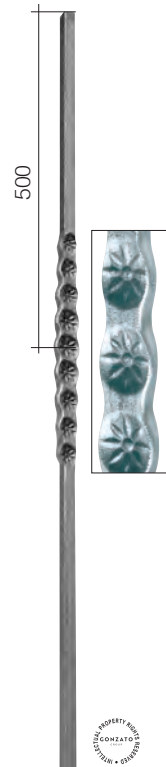

Art. 1718/18
Ø 25 mm
H 1200 mm

Newel Post - Caposaldo

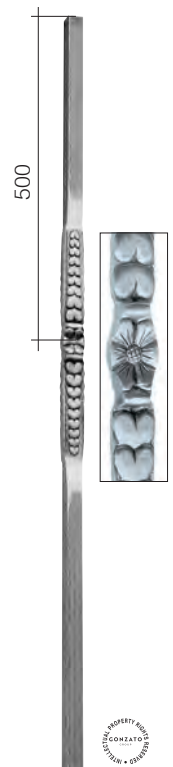

Art. 1718/17
Ø 25 mm
H 1200 mm



Art. GD273/2
Ø 14 x 14 mm
H 1000 mm



Art. GD273/4
Ø 14 x 14 mm
H 1000 mm



Art. GD273/5
Ø 12 x 12 mm
H 1000 mm
Art. GD273/6
Ø 14 x 14 mm
H 1000 mm



Art. GD274/1
Ø 12 x 12 mm
H 1000 mm
Art. GD274/2
Ø 14 x 14 mm
H 1000 mm



Art. GD274/5
Ø 12 x 12 mm
H 1000 mm
Art. GD274/6
Ø 14 x 14 mm
H 1000 mm



Art. GD274/3
Ø 12 x 12 mm
H 1000 mm
Art. GD274/4
Ø 14 x 14 mm
H 1000 mm

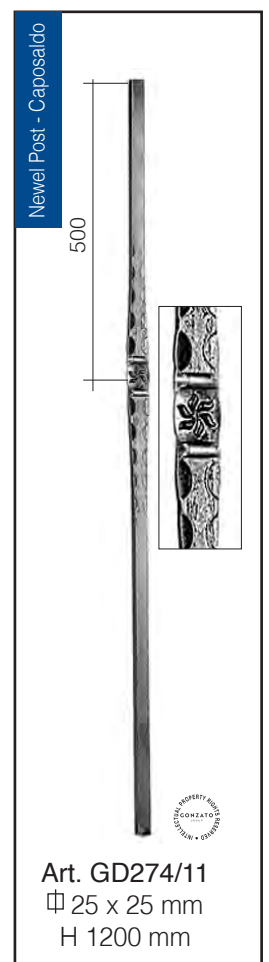

Art. GD274/11
Ø 25 x 25 mm
H 1200 mm

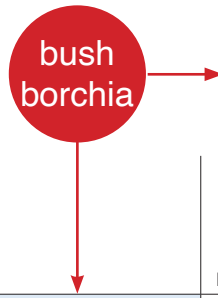

| Sec.Sez. | Finish - Finitura | Bush - Borchia | Art. | Art. |
|----------|--|--|----------|----------|
| Ø 12 mm | Plain Liscio  | 1393/19  | 1746/1 | 1746/2 |
| | Hammered Spigolato  | | 1746/3 | 1746/4 |
| | Bark effect Corteccia  | | 1746/5 | - |
| | Plain Liscio  | 1391/21 cast steel bush borchia ferro fuso  | 1176/1/S | 1176/2/S |
| | Bark effect Corteccia  | | 1176/3/S | - |
| Ø 14 mm | Hammered Spigolato  | 128/2  | 64/1/3 | 64/1/4 |
| Ø 12 mm | Plain Liscio  | 1466/4 brass - ottone  | 1179/1 | 1179/2 |
| | Plain Liscio  | 1466/14 lathed bush borchia tornita  | GD275/1 | GD275/7 |
| | Plain Liscio  | 1393/27/S  | 1177/5 | 1177/6 |
| Ø 14 mm | Plain Liscio  | 1466/14 lathed bush borchia tornita  | GD275/1 | GD275/7 |
| | Plain Liscio  | 1393/28/S  | 1177/7 | 1177/8 |
| | Plain Liscio  | 1466/13 lathed bush borchia tornita  | GD275/3 | GD275/9 |
| | Plain Liscio  | 1466/15 lathed bush borchia tornita  | GD275/2 | GD275/8 |
| | Plain Liscio  | 1466/5 brass - ottone  | 1179/3 | 1179/4 |



PLAIN PICKETS - PALETTI LISCI
TUBE-TUBO Ø 30 mm THICKN. - SPESS. 1,5 mm



Art. 148/1
Ø 30 mm
H 900 mm



Art. 148/2
Ø 30 mm
H 900 mm



Art. 149/1
Ø 30 mm
H 900 mm



Art. 149/2
Ø 30 mm
H 900 mm



Art. 537/8
Ø 30 mm
H 1000 mm



Art. 537/9
Ø 30 mm
H 1000 mm



Art. 149/4
Ø 30 mm
H 1000 mm



Art. 149/3
Ø 30 mm
H 400 mm



Art. 537/1
Ø 30 mm
H 1000 mm



Art. 537/3
Ø 30 mm
H 1000 mm



Art. 537/4
Ø 30 mm
H 1000 mm



Art. 537/5
Ø 30 mm
H 1000 mm



Art. 537/6
Ø 30 mm
H 1000 mm



Art. 537/7
Ø 30 mm
H 1000 mm

PLAIN PICKETS - PALETTI LISCI
TUBE-TUBO Ø 30 mm THICKN. - SPESS. 1,5 mm

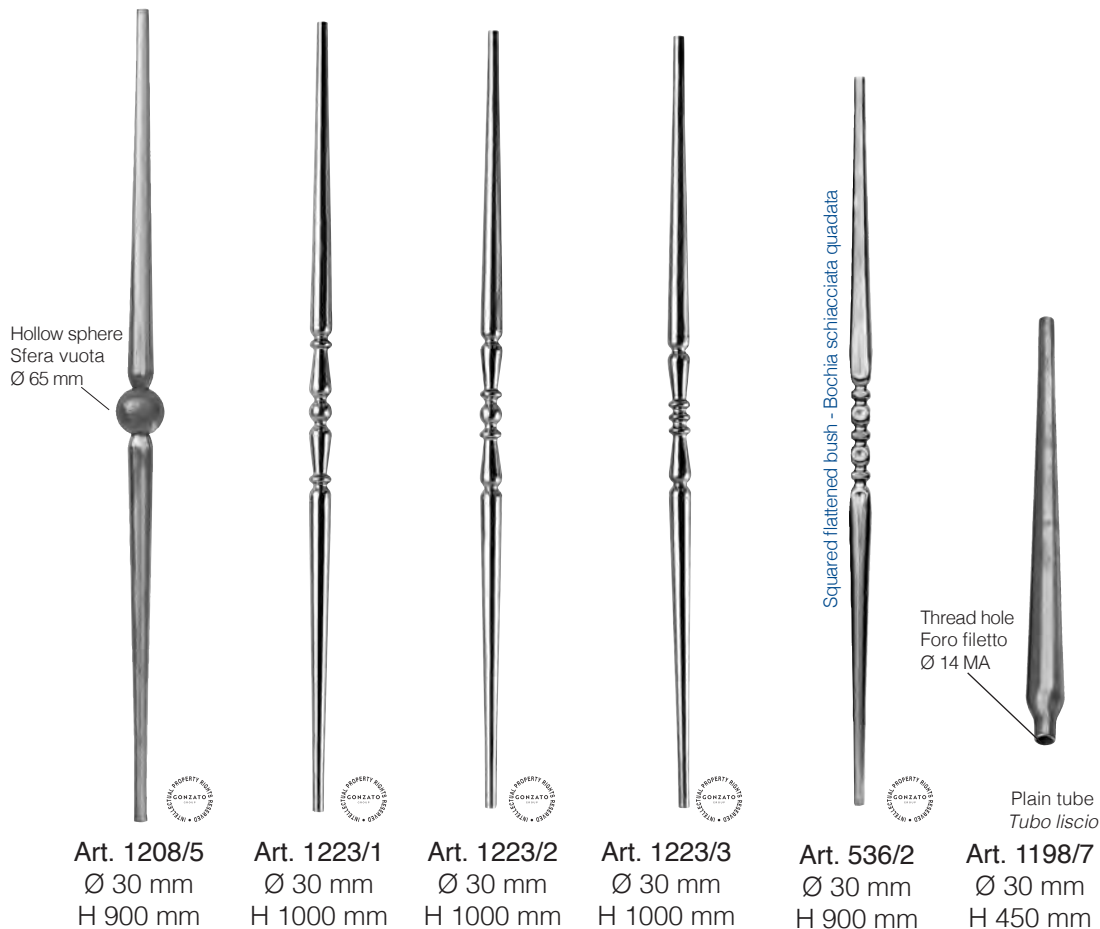

Art. 1208/5
Ø 30 mm
H 900 mm

Art. 1223/1
Ø 30 mm
H 1000 mm

Art. 1223/2
Ø 30 mm
H 1000 mm

Art. 1223/3
Ø 30 mm
H 1000 mm

Art. 536/2
Ø 30 mm
H 900 mm

Art. 1198/7
Ø 30 mm
H 450 mm

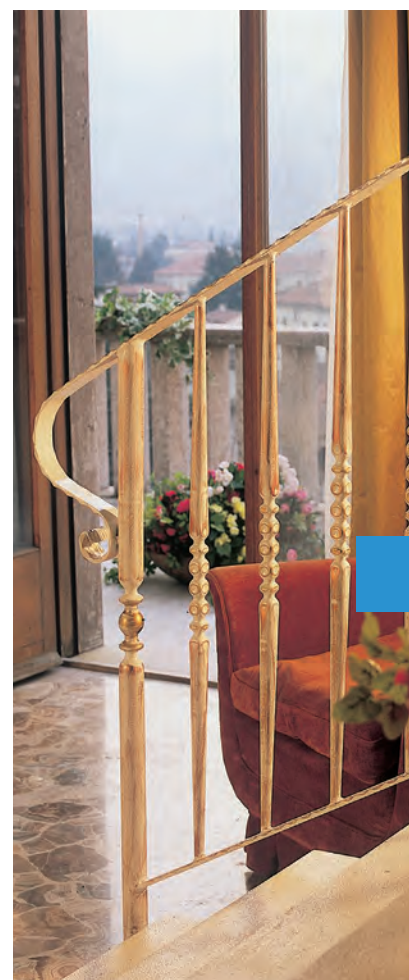

Ceramic bushing hand painted
Borchia in ceramica dipinta a mano

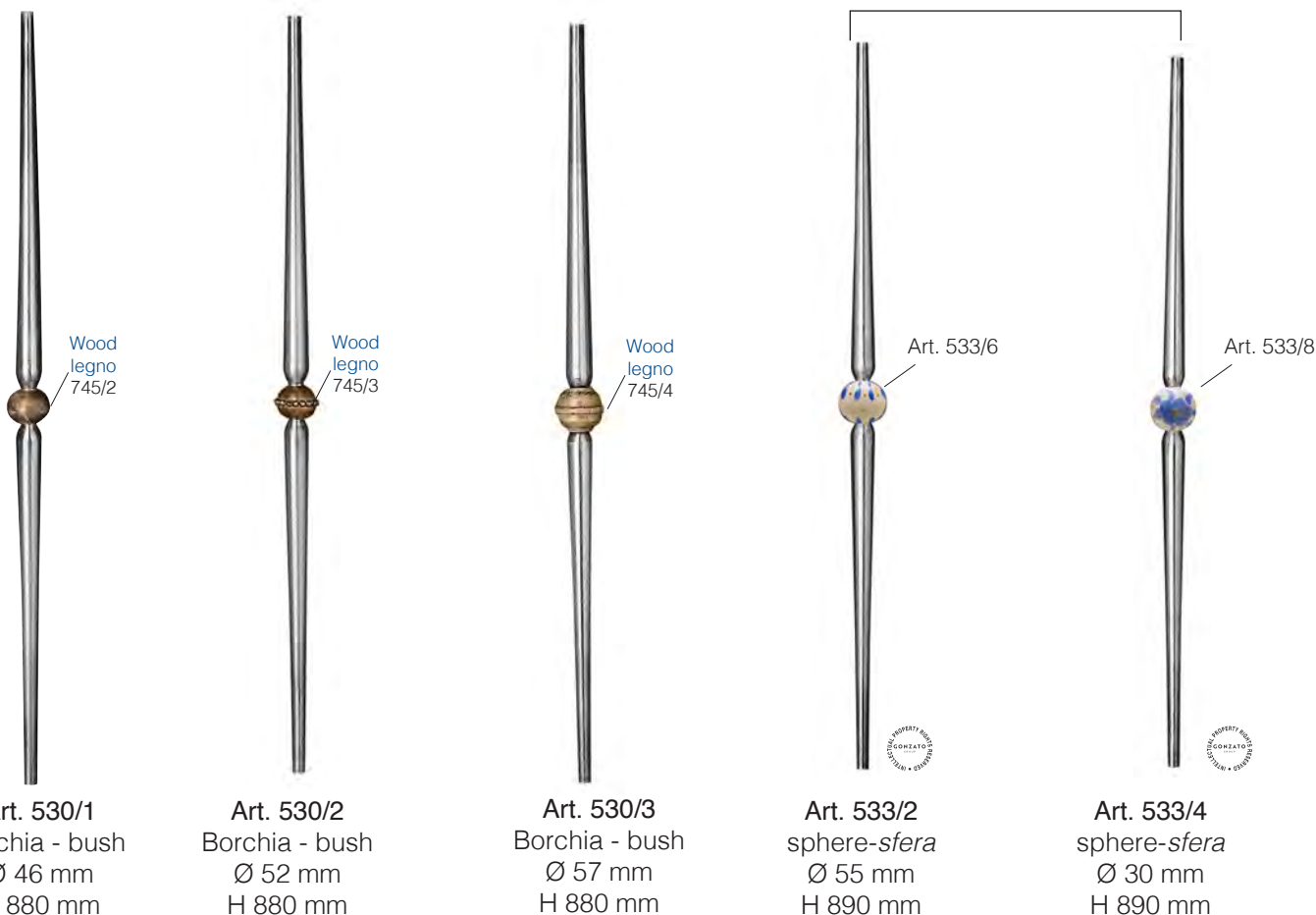

Art. 530/1
Borchia - bush
Ø 46 mm
H 880 mm

Art. 530/2
Borchia - bush
Ø 52 mm
H 880 mm

Art. 530/3
Borchia - bush
Ø 57 mm
H 880 mm

Art. 533/2
sphere-sfera
Ø 55 mm
H 890 mm

Art. 533/4
sphere-sfera
Ø 30 mm
H 890 mm

TUBE - TUBO Ø 40 mm THICKN. - SPESS. 2 mm



Art. 146/1
Ø 40 mm
H 900 mm



Art. 146/4
Ø 40 mm
H 900 mm

Squared flattened bush - Bochia schiacciata quadrata



Art. 536/3
Ø 40 mm
H 900 mm

Squared flattened bush - Bochia schiacciata quadrata



Art. 536/4
Ø 40 mm
H 900 mm

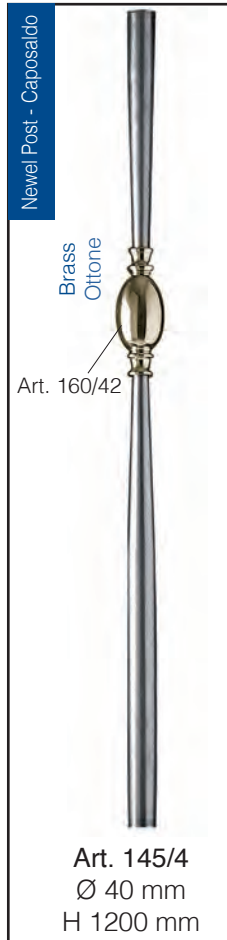

Newel Post - Caposaldo

Brass
Ottone

Art. 160/42

Art. 145/4
Ø 40 mm
H 1200 mm



Newel Post - Caposaldo

Brass
Ottone

Art. 160/42

Art. 160/44

Art. 145/5
Ø 40 mm
H 1300 mm

TUBE - TUBO Ø 30 mm THICKN. - SPESS. 1,5 mm



Brass
Ottone
Art. 160/B/7

Art. 529/5
Ø 30 mm
H 900 mm

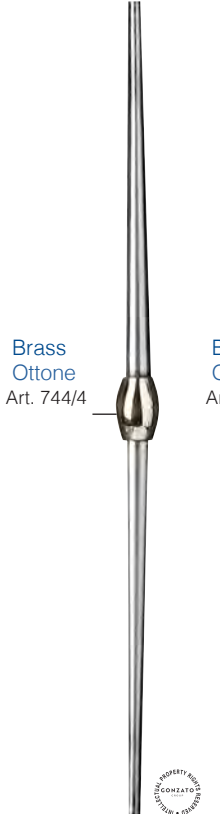

Brass
Ottone
Art. 744/4

Art. 527/1
Ø 30 mm
H 920 mm

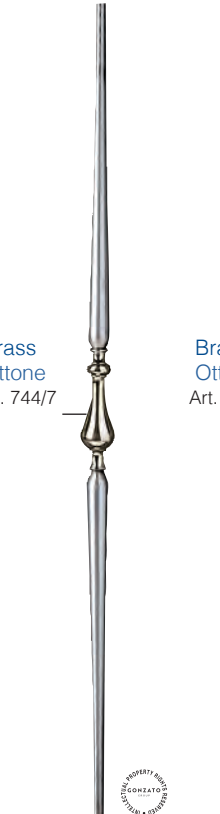

Brass
Ottone
Art. 744/7

Art. 527/2
Ø 30 mm
H 1000 mm

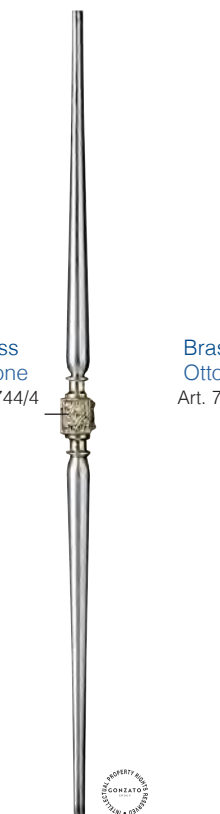

Brass
Ottone
Art. 744/4

Art. 527/3
Ø 30 mm
H 1000 mm

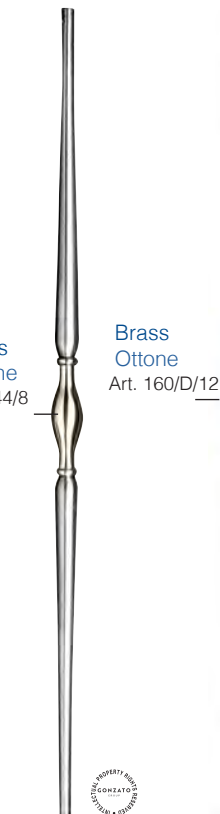

Brass
Ottone
Art. 744/8

Art. 529/8
Ø 30 mm
H 1000 mm



Brass
Ottone
Art. 160/D/12

Art. 525/1
Ø 30 mm
H 930 mm



Brass
Ottone
Art. 161/4

Art. 144/3
Ø 30 mm
H 900 mm

STEEL TUBE BALUSTERS - TUBO DI ACCIAIO Ø 40 mm THICKN. - SPESS. 2 mm



Art. 1793/5
Ø 40 mm
H 1000 mm



Art. 146/2
Ø 40 mm
H 1000 mm



Art. 146/3
Ø 40 mm
H 900 mm



Art. 147/1
Ø 40 mm
H 1000 mm



Art. 147/2
Ø 40 mm
H 1000 mm



Art. 1793/4
Ø 50 mm
H 1000 mm

Tube - Tubo Ø 50 x 2 mm

TUBE - TUBO Ø 30 mm
THICKN. - SPESS. 1,5 mm

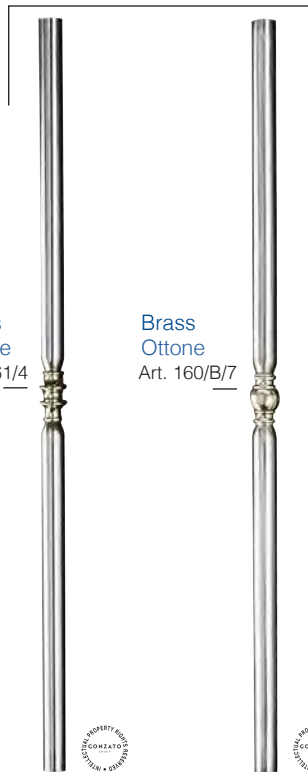

Brass
Ottone
Art. 161/4

Brass
Ottone
Art. 160/B/7

Art. 529/1
Ø 30 mm
H 900 mm

Art. 529/4
Ø 30 mm
H 900 mm



Art. 810/1
Art. 810/2

Tube-Tubo
60 x 60 mm

220

Art. 1207/1
L 85 mm
H 1200 mm



Art. 810/1
Art. 810/2

Tube-Tubo
80 x 80 mm

220

Art. 1207/2
L 105 mm
H 1200 mm



Art. 810/2
Art. 810/3

Tube-Tubo
Ø 100 mm

Art. 1247/2
Ø 135 mm
H 1000 mm

GROOVED PICKETS - PALETTI RIGATI
TUBE-TUBO Ø 30 mm THICKN. - SPESS. 1,5 mm

Some Arteferro tubular pickets appear in the film "007 GoldenEye" (1995) directed by Martin Campbell

Alcuni paletti in tubo Arteferro appaiono nel film "007 GoldenEye" (1995) diretto da Martin Campbell



Grooved tube
Tubo rigato

Art. 1794/10
Ø 30 x 1,5 mm
L 3000 mm
Art. 1794/10/6000
Ø 30 x 1,5 mm
L 6000 mm



| | | | | | |
|-------------------------------------|-------------------------------------|-------------------------------------|-------------------------------------|-------------------------------------|-------------------------------------|
| Art. 1231/1 Ø 30 mm H 1000 mm | Art. 1229/1 Ø 30 mm H 1000 mm | Art. 1231/2 Ø 30 mm H 1000 mm | Art. 1229/2 Ø 30 mm H 1000 mm | Art. 1229/4 Ø 30 mm H 1000 mm | Art. 1229/5 Ø 30 mm H 1000 mm |
|-------------------------------------|-------------------------------------|-------------------------------------|-------------------------------------|-------------------------------------|-------------------------------------|



| | | | | | | |
|-------------------------------------|-------------------------------------|-------------------------------------|-------------------------------------|-------------------------------------|-------------------------------------|------------------------------------|
| Art. 1231/3 Ø 30 mm H 1000 mm | Art. 1230/2 Ø 30 mm H 1000 mm | Art. 1230/4 Ø 30 mm H 1000 mm | Art. 1229/3 Ø 30 mm H 1000 mm | Art. 1230/1 Ø 30 mm H 1000 mm | Art. 1229/6 Ø 30 mm H 1000 mm | Art. 1229/8 Ø 30 mm H 500 mm |
|-------------------------------------|-------------------------------------|-------------------------------------|-------------------------------------|-------------------------------------|-------------------------------------|------------------------------------|

GROOVED PICKETS - PALETTI RIGATI
TUBE-TUBO Ø 30 mm THICKN. - SPESS. 1,5 mm



Brass
Ottone
Art. 160/D/12

Art. 1233/2
Ø 30 mm
H 1000 mm

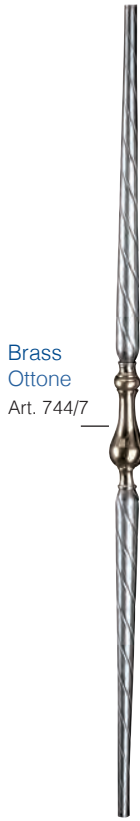

Brass
Ottone
Art. 744/7

Art. 1233/3
Ø 30 mm
H 1000 mm

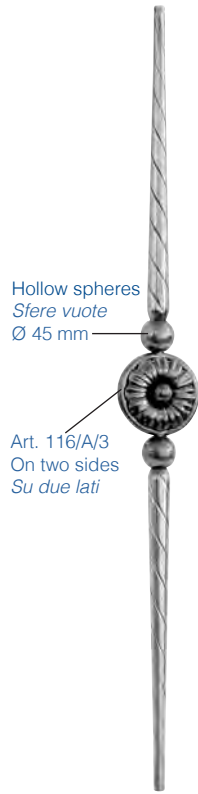

Hollow spheres
Sfere vuote
Ø 45 mm
Art. 116/A/3
On two sides
Su due lati

Art. 1239/1
Ø 30 mm
113 x 1030 mm



Thread hole
Foro filetto
Ø 14 MA

Grooved tube
Tubo rigato

Art. 1198/8
Ø 30 mm
H 450 mm



Newel Post - Caposaldo

Brass
Ottone
Art. 160/42

Art. 1794/6
Ø 40 mm
H 1200 mm



Art. 1794/1
Ø 40 mm
H 1000 mm



Art. 1794/2
Ø 40 mm
H 1000 mm



Art. 1794/8
Ø 40 mm
H 1200 mm





Newel Post - Caposaldo



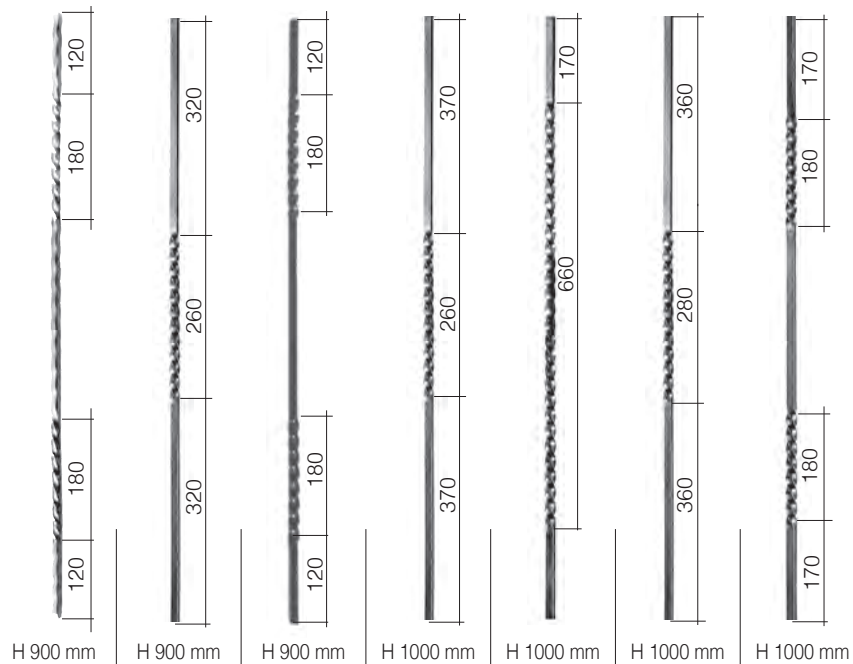



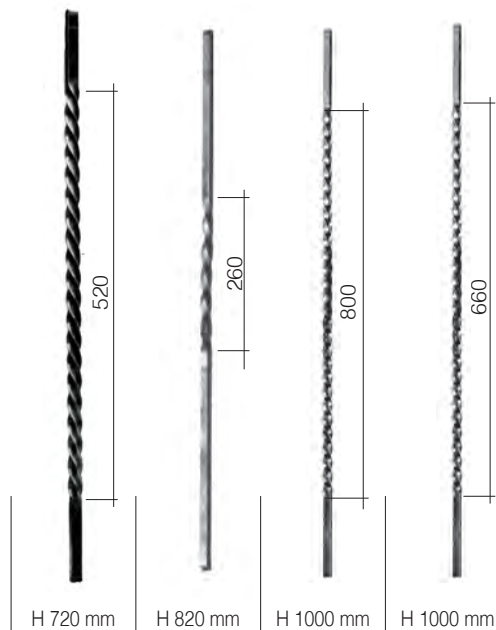

Grooved tube
Tubo rigato

Art. 1794/9
Ø 40 x 2 mm
L 3000 mm
Art. 1794/9/6000
Ø 40 x 2 mm
L 6000 mm



| Sec.Sez. | Finish - Finitura | Art. | Art. | Art. | Art. | Art. | Art. | Art. |
|----------|---|---------|---------|---------|----------|---------|---------|---------|
| Φ 12 mm | Plain Liscio  | - | 65/8 | 53/3 | - | 1148/2 | 1148/5 | 1148/8 |
| | Hammered Spigolato  | 118/B/3 | - | - | - | - | - | - |
| | Bark effect Corteccia  | - | - | - | - | 1148/11 | 1148/14 | 1148/17 |
| | Grooved Rigato  | - | 118/H/2 | 118/H/1 | 118/H/30 | 1151/7 | 1151/5 | 1151/6 |
| Φ 14 mm | Plain Liscio  | - | 70/D/3 | 70/D/2 | - | 1148/3 | 1148/6 | 1148/9 |



| Sec.Sez. | Finish - Finitura | Art. | Art. | Art. | Art. |
|-------------|--|-------|------|--------|---------|
| Φ 8 mm | Plain Liscio  | 119/7 | - | - | - |
| Φ 8 mm | Grooved Rigato  | - | - | 1723/1 | - |
| Φ 10 mm | Plain Liscio  | - | - | - | 1148/1 |
| Φ 12 mm | Plain Liscio  | - | 65/7 | - | - |
| ∇ 14 x 8 mm | Plain Liscio  | - | - | - | 1148/19 |



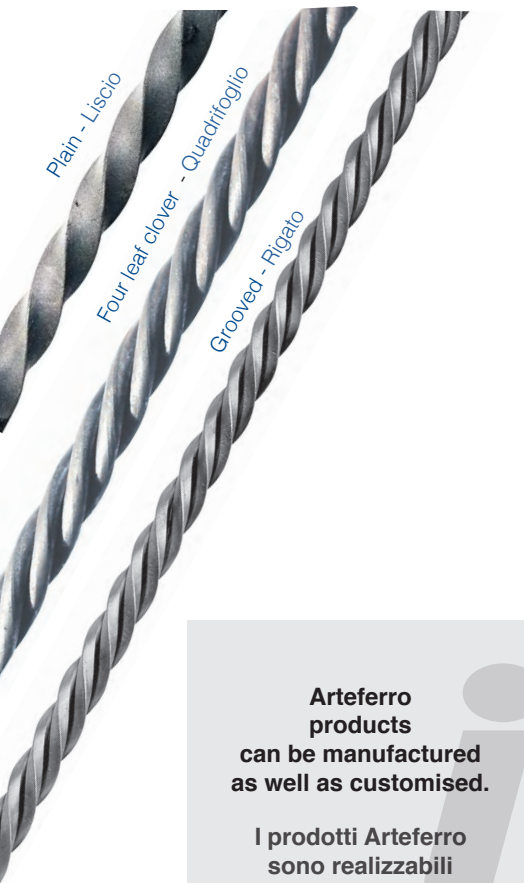

Arteferro products can be manufactured as well as customised.

I prodotti Arteferro sono realizzabili anche su misura.

**TWISTS WITH TRIPLE TWISTING RIGHT/LEFT
TORCIGLIONI CON TRIPLA ATTORCIGLIATURA DESTRA/SINISTRA**

| Sec.Sez. | Finish - Finitura | H 900 mm | | | H 1000 mm | | | H 1200 mm | | |
|----------|-------------------------------|----------|----------|----------|-----------|------|------|-----------|------|--|
| | | Art. | Art. | Art. | Art. | Art. | Art. | Art. | Art. | |
| Φ 12 mm | Plain Liscio | GD106/1 | - | GD106/7 | | | | | | |
| | Four-leaf clover Quadrifoglio | GD106/10 | GD106/13 | GD106/16 | | | | | | |
| | Grooved Rigato | GD106/19 | GD106/22 | - | | | | | | |
| Φ 14 mm | Plain Liscio | GD106/2 | GD106/5 | GD106/8 | | | | | | |
| | Four-leaf clover Quadrifoglio | GD106/11 | GD106/14 | GD106/17 | | | | | | |
| | Grooved Rigato | GD106/20 | GD106/23 | GD106/26 | | | | | | |
| Φ 16 mm | Plain Liscio | GD106/3 | GD106/6 | GD106/9 | | | | | | |
| | Four-leaf clover Quadrifoglio | GD106/12 | GD106/15 | GD106/18 | | | | | | |
| | Grooved Rigato | GD106/21 | GD106/24 | GD106/27 | | | | | | |



| Sezione | Finish - Finitura | Newel Post - Caposaldo | | | | |
|---------|-------------------|------------------------|-------|--------|--------|--------|
| | | Art. | Art. | Art. | Art. | Art. |
| Φ 20 mm | Plain Liscio | - | 113/7 | - | 119/25 | 1751/5 |
| Φ 25 mm | Beveled Smussato | 112/3 | - | - | - | - |
| Φ 30 mm | Plain Liscio | - | 113/8 | GD22/6 | 119/27 | - |



| Section Sezione | Finish - Finitura | H 720 mm A = 520 mm | H 820 mm A = 620 mm | H 900 mm A = 700 mm | H 1200 mm A = 900 mm |
|--------------------|--|------------------------|------------------------|--------------------------|-------------------------|
| | | Art. | Art. | Art. | Art. |
| 16 x 4 mm | Plain Liscio  | 119/4 | 119/11 | 119/18 BEST PRICE | - |
| 20 x 4 mm | | 119/5 | 119/12 | 119/19 | - |
| 20 x 6 mm | | 119/6 | 119/13 | 119/20 | - |
| 30 x 8 mm | | - | - | 118/H/3 | 118/H/4 |



| Section Sezione | Finish - Finitura | H 720 mm A = 520 mm | H 820 mm A = 620 mm | H 900 mm A = 700 mm |
|--------------------|---|------------------------|------------------------|------------------------|
| | | Art. | Art. | Art. |
| 12 x 12 mm | Plain - Plain  | 119/9 | 119/16 | 119/23 |
| 14 x 14 mm | | 119/10 | 119/17 | 119/24 |



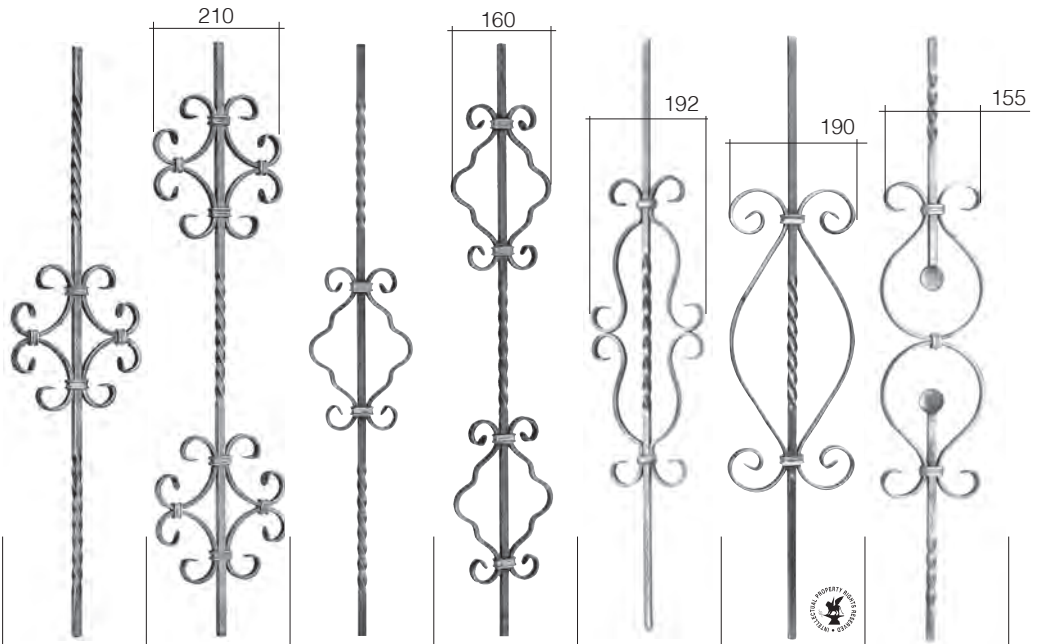

| Sec.Sez. | Finish - Finitura | Art. | Art. | Art. | Art. | Art. | Art. | Art. |
|----------|-------------------|-------|-------|--------|--------|--------|-------|---------|
| Ø 12 mm | Plain Liscio | 584/1 | 584/2 | 1127/1 | 1127/2 | 64/E/3 | 539/1 | 134/H/1 |

Pag.
40

Large choice
of twisted bars
3m long

Ampla
scelta di barre
attorcigliate 3 mt.

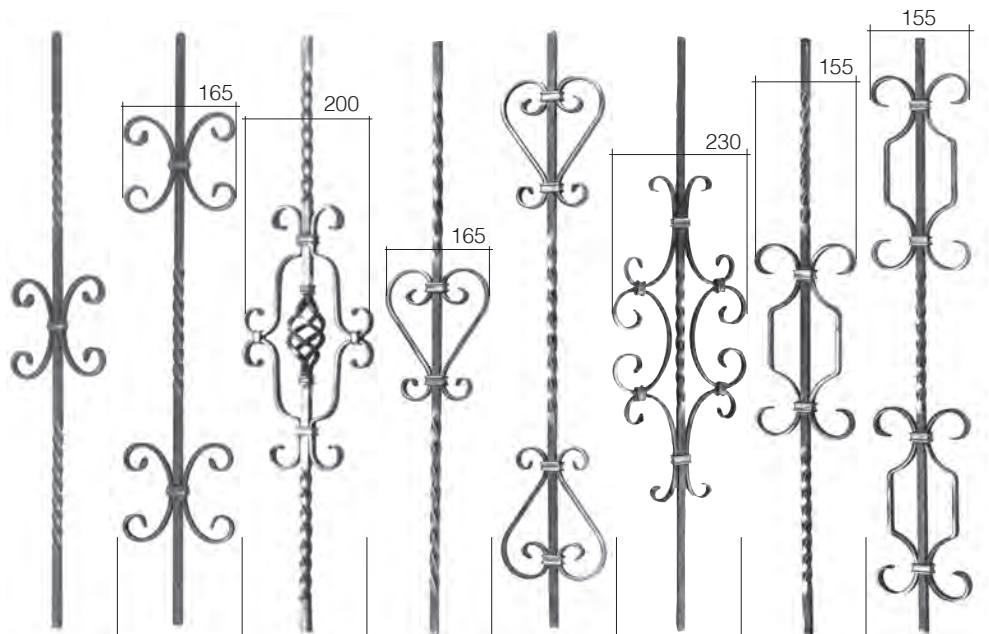

| Sec.Sez. | Finish - Finitura | Art. | Art. | Art. | Art. | Art. | Art. | Art. |
|----------|-------------------|-------|-------|--------|---------|---------|---------|---------|
| Ø 12 mm | Plain Liscio | 584/4 | 584/5 | 64/B/2 | 584/B/2 | 584/B/1 | 584/A/6 | 584/A/5 |
| Ø 14 mm | Plain Liscio | - | - | 64/B/5 | - | - | - | - |

Plain - Liscio

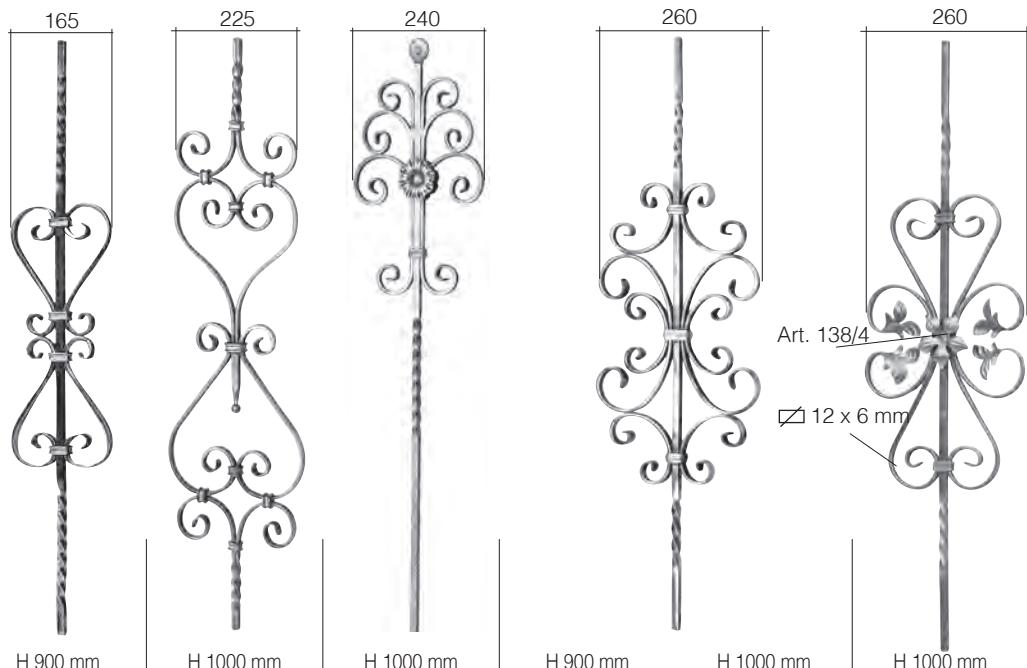



| Sec.Sez. | Finish - Finitura | Art. | Art. | Art. | Art. | Art. | Art. |
|----------|-------------------|---------|--------|--------|--------|--------|--------|
| Φ 12 mm | Plain Liscio | 584/B/3 | 1124/1 | 1124/2 | 52/F/1 | 1753/3 | 1753/6 |



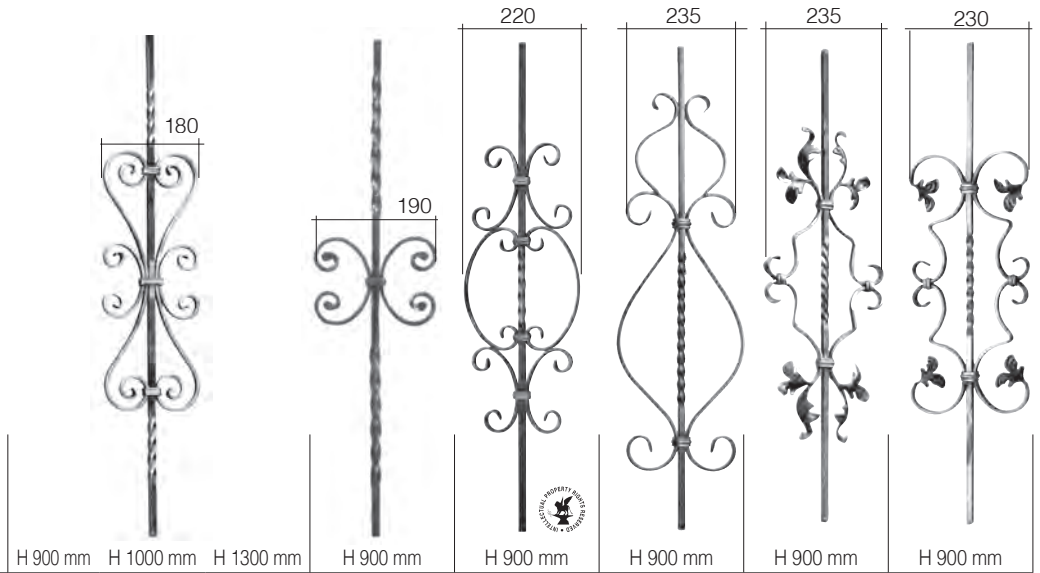
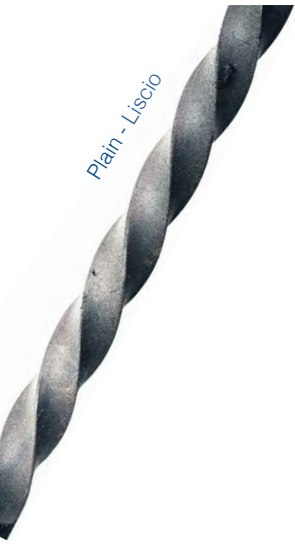

| Sec.Sez. | Finish - Finitura | Art. | Art. | Art. |
|----------|-------------------|--------|--------|--------|
| Φ 12 mm | Plain Liscio | 52/A/3 | 52/A/5 | 52/A/2 |



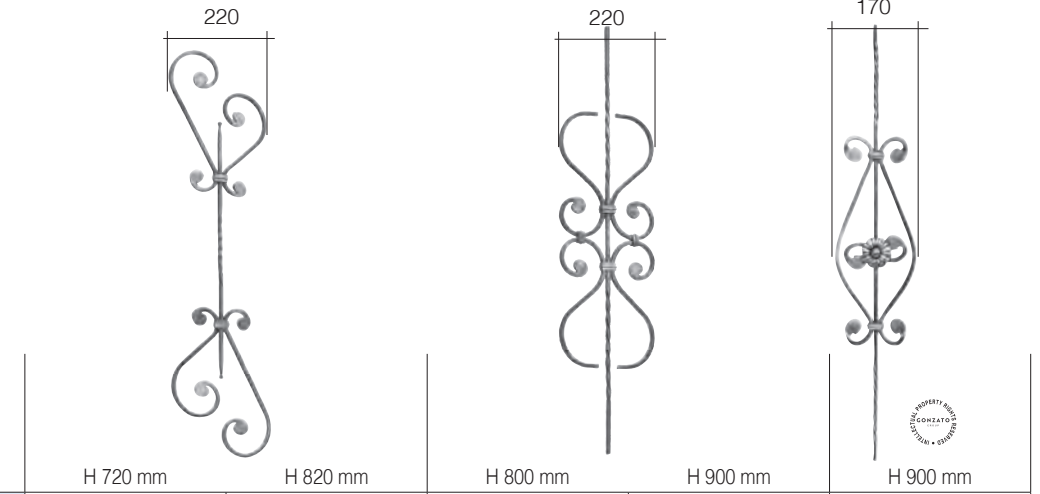

| Sec.Sez. | Finish - Finitura | Art. | Art. | Art. | Art. | Art. | Art. | Art. | Art. |
|----------|--|------|--------|------|------|--------|---------|------|--------|
| ∅ 12 mm | Plain Liscio  | 49/3 | 1753/1 | - | 51/1 | 1124/3 | 134/F/8 | 53/1 | 52/E/4 |
| ∅ 14 mm | Plain Liscio  | 49/5 | - | 49/7 | 51/4 | - | - | - | - |



| Sec.Sez. | Finish - Finitura | Art. | Art. | Art. | Art. | Art. |
|----------|--|------|------|------|------|-------|
| ∅ 8 mm | Plain Liscio  | 55/5 | 55/6 | 56/3 | 56/4 | 538/1 |

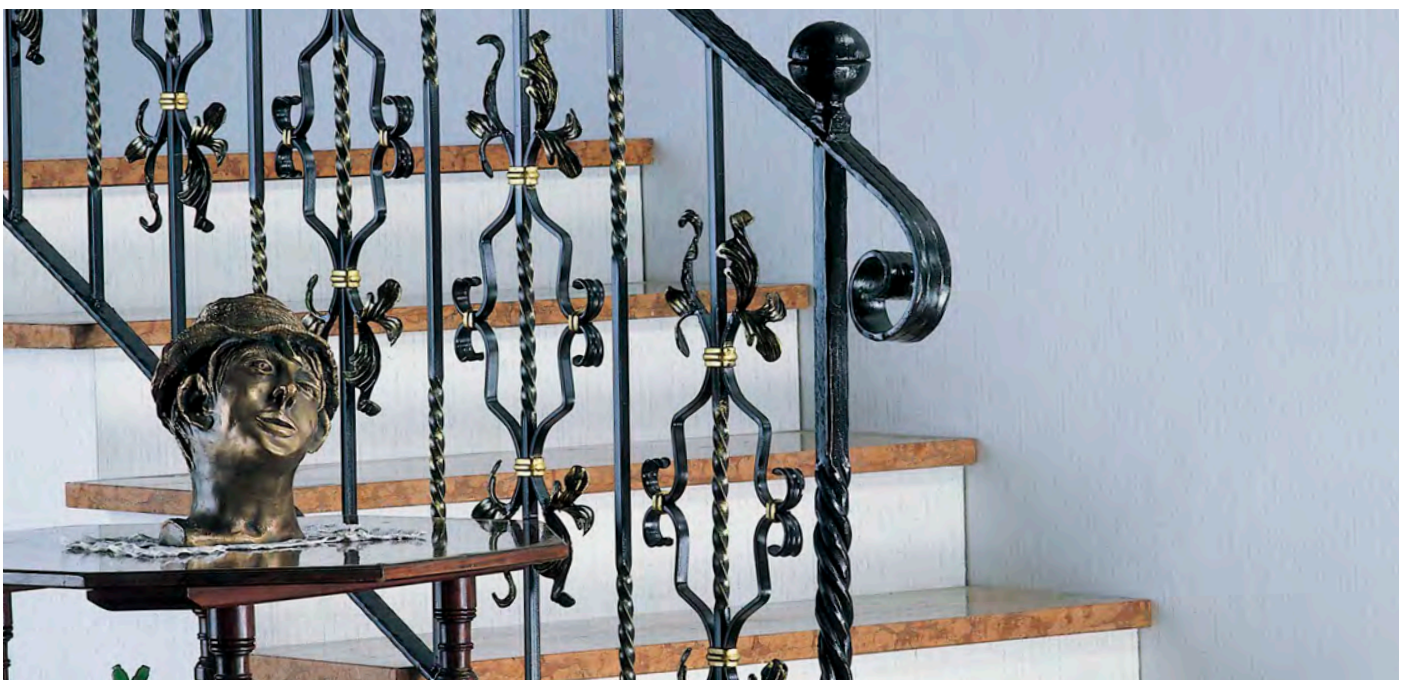



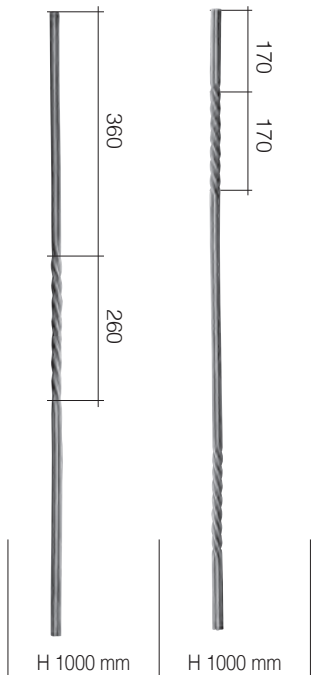

Four leaf clover - Quadrifoglio



Plain - Liscio



| Sec.Sez. | Finish - Finitura | Art. | Art. |
|----------|--|---------|---------|
| Ø 14 mm | Four-leaf clover Quadrifoglio  | 1150/9 | 1150/10 |
| Ø 16 mm | Four-leaf clover Quadrifoglio  | 1150/12 | 1150/13 |

| Sec.Sez. | Finish - Finitura | Art. |
|----------|--|--------|
| Ø 12 mm | Plain Liscio  | 1122/2 |



Art. 66/5
Ø 16 x 12 mm
180 x 720 mm
Art. 66/7
Ø 16 x 12 mm
180 x 900 mm



Art. 66/9
Ø 16 x 12 mm
180 x 820 mm



Art. 97/1
Ø 14 x 14 mm
130 x 830 mm



Art. 529/7
Ø 20 x 20 mm
H 1000 mm



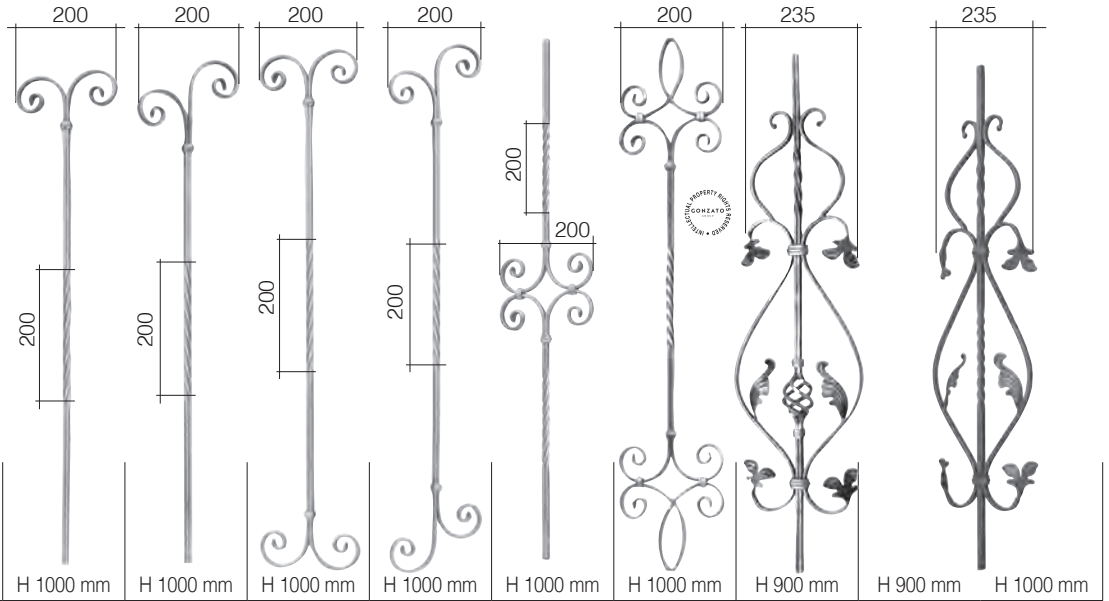

Art. 60/2
Ø 20 x 4 mm
175 x 820 mm



| Sec. Sez. | Finish Finitura | Art. | Art. | Art. | Art. | Art. | Art. | Art. | Art. | Art. |
|-----------|--|--------|--------|--------|--------|--------|--------|--------|------|--------|
| Ø 12 mm | Grooved Rigato  | 1695/1 | 1695/2 | 1695/3 | 1695/4 | 1695/6 | 1688/3 | 52/E/3 | 52/2 | 1753/7 |

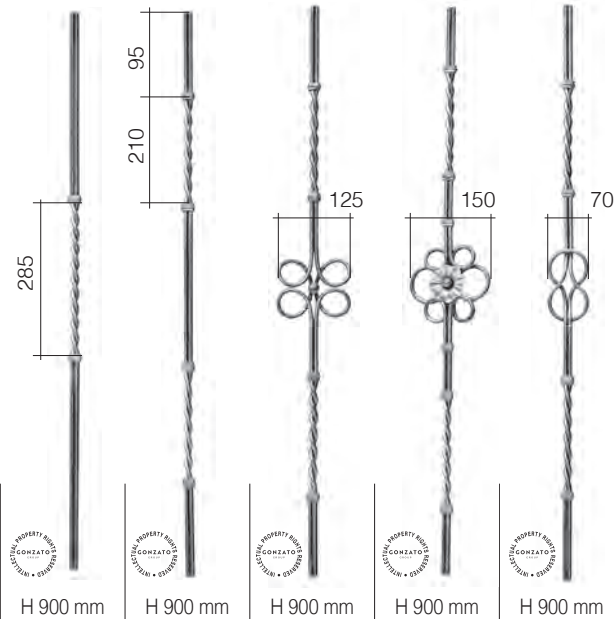



| Sec.Sez. | Finish - Finitura | H 900 mm | H 900 mm | H 900 mm | H 900 mm | H 900 mm |
|----------|---|----------|----------|----------|----------|----------|
| Ø 8 mm | Plain Liscio | Art. | Art. | Art. | Art. | Art. |
| |  | 617/7 | 617/6 | 615/3 | 615/1 | 615/4 |

BEST PRICE

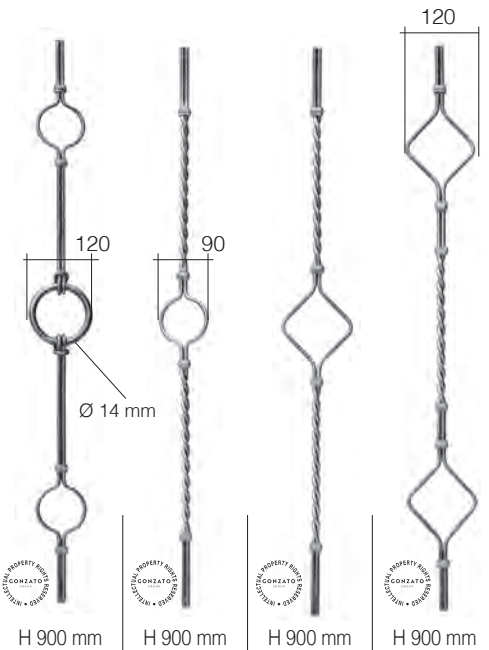

| Sec.Sez. | Finish - Finitura | H 900 mm | H 900 mm | H 900 mm | H 900 mm |
|----------|---|----------|----------|----------|----------|
| Ø 8 mm | Plain Liscio | Art. | Art. | Art. | Art. |
| |  | 615/2 | 617/1 | 617/3 | 617/4 |



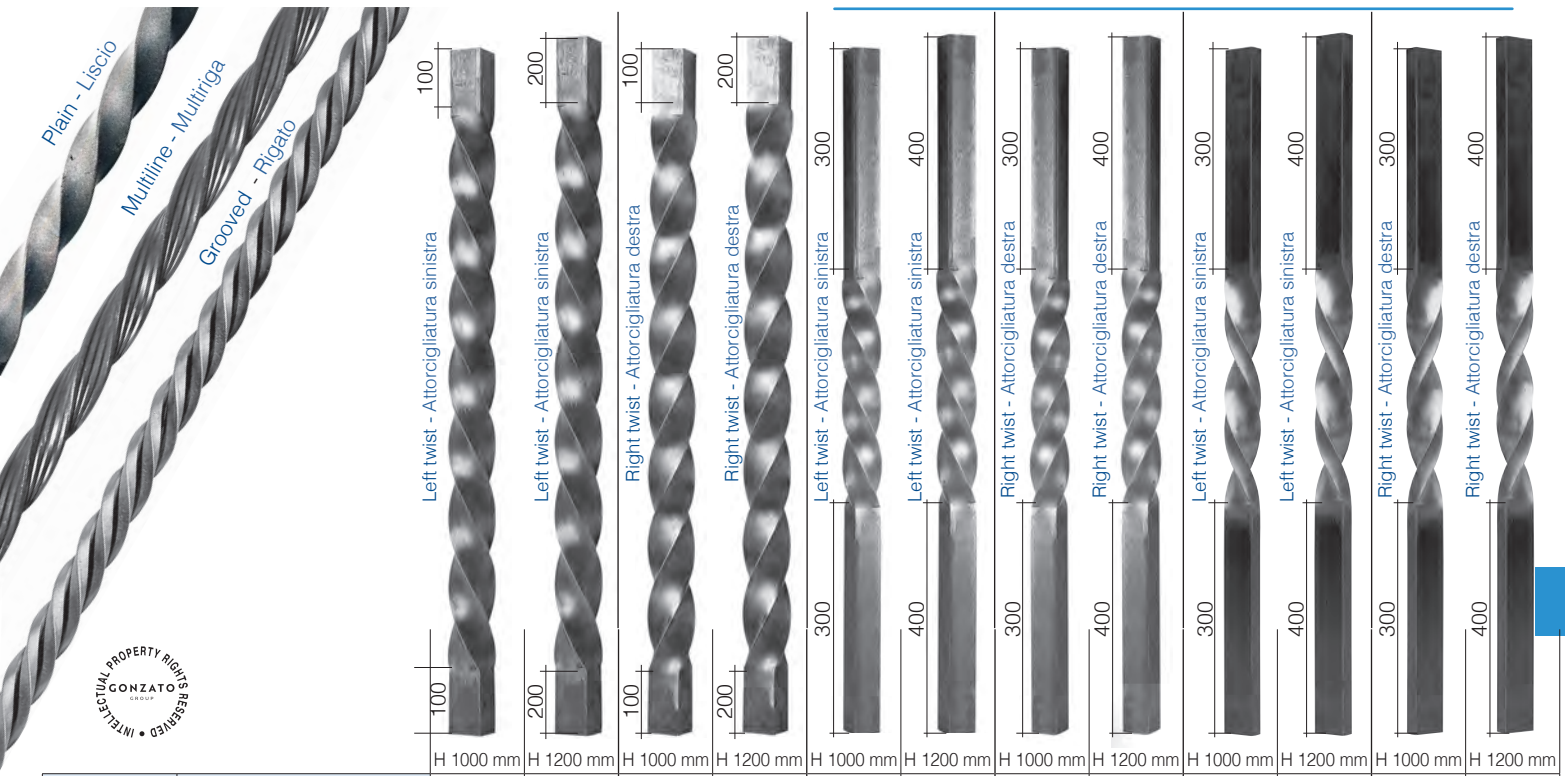

| Sec.Sez. | Finish - Finitura | Art. | Art. | Art. | Art. | Art. | Art. | Art. | Art. | Art. | Art. | Art. | Art. |
|--------------|---------------------|---------|---------|---------|---------|---------|---------|---------|---------|---------|---------|---------|---------|
| Φ 30 mm | Plain Liscio | 119/27 | 1724/20 | 1724/25 | 1724/26 | 1724/31 | 1724/32 | 1724/37 | 1724/38 | - | - | - | - |
| | Multiline Multiriga | 1725/5 | 1725/6 | 1725/11 | 1725/12 | 1725/17 | 1725/18 | 1725/23 | 1725/24 | - | - | - | - |
| | Grooved Rigato | 1724/43 | 1724/44 | 1724/49 | 1724/50 | 1724/55 | 1724/56 | 1724/61 | 1724/62 | - | - | - | - |
| Φ 40 mm | Plain Liscio | 119/28 | 1724/19 | 1724/23 | 1724/24 | 1724/29 | 1724/30 | 1724/35 | 1724/36 | - | - | - | - |
| | Multiline Multiriga | 1725/3 | 1725/4 | 1725/9 | 1725/10 | 1725/15 | 1725/16 | 1725/21 | 1725/22 | - | - | - | - |
| | Grooved Rigato | 1724/41 | 1724/42 | 1724/47 | 1724/48 | 1724/53 | 1724/54 | 1724/59 | 1724/60 | - | - | - | - |
| Φ 50 mm | Plain Liscio | 1724/17 | 1724/18 | 1724/21 | 1724/22 | 1724/27 | 1724/28 | 1724/33 | 1724/34 | - | - | - | - |
| | Multiline Multiriga | 1725/1 | 1725/2 | 1725/7 | 1725/8 | 1725/13 | 1725/14 | 1725/19 | 1725/20 | - | - | - | - |
| | Grooved Rigato | 1724/39 | 1724/40 | 1724/45 | 1724/46 | 1724/51 | 1724/52 | 1724/57 | 1724/58 | - | - | - | - |
| ∇ 50 x 25 mm | Plain Liscio | 1724/3 | 1724/4 | 1724/7 | 1724/8 | - | - | - | - | 1724/11 | 1724/12 | 1724/15 | 1724/16 |
| ∇ 60 x 30 mm | Plain Liscio | 1724/1 | 1724/2 | 1724/5 | 1724/6 | - | - | - | - | 1724/9 | 1724/10 | 1724/13 | 1724/14 |





159/3 \varnothing 12 mm
159/4 \varnothing 14 mm
159/5 \varnothing 16 mm

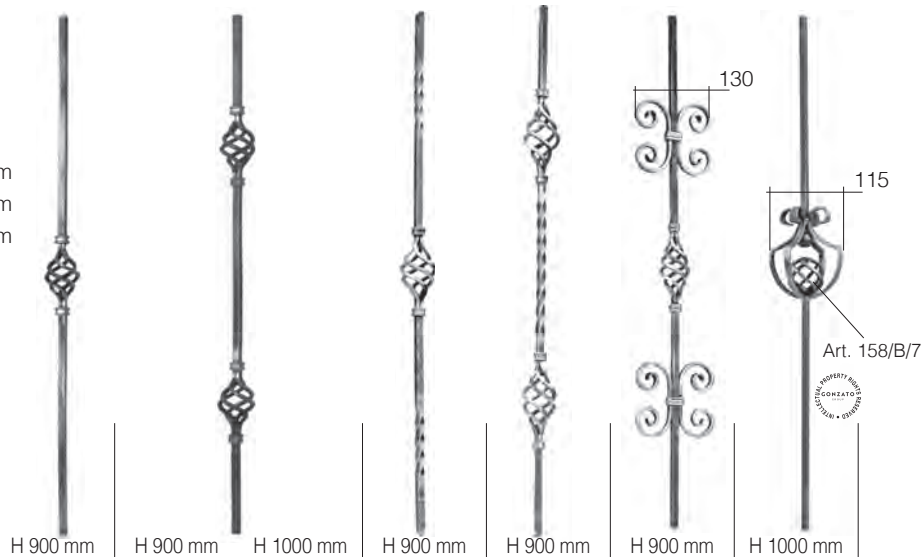

| Sec.Sez. | Finish - Finitura | | Art. | Art. | Art. | Art. | Art. | Art. | Art. |
|---------------------|-----------------------|--|---------|---------|---------|-------|-------|------|--------|
| \varnothing 12 mm | Plain Liscio | | 48/A/2 | 48/A/1 | - | 48/2 | 48/1 | 48/5 | 1058/1 |
| | Hammered Spigolato | | 48/4 | 48/3 | - | - | - | - | - |
| | Hammered Martellato | | 48/A/4 | 48/A/3 | - | - | - | - | - |
| | Grooved Rigato | | - | - | 1151/4 | - | - | - | - |
| | Bark effect Corteccia | | - | 48/A/12 | 1733/17 | - | - | - | - |
| \varnothing 14 mm | Plain Liscio | | 48/A/6 | 48/A/5 | - | 48/7 | 48/6 | - | - |
| | Hammered Spigolato | | 48/9 | 48/8 | - | - | - | - | - |
| | Hammered Martellato | | 48/A/8 | 48/A/7 | - | - | - | - | - |
| | Bark effect Corteccia | | - | - | 1733/19 | - | - | - | - |
| \varnothing 16 mm | Plain Liscio | | 48/A/10 | 48/A/9 | - | 48/12 | 48/11 | - | - |
| | Hammered Spigolato | | 48/14 | 48/13 | - | - | - | - | - |
| | Hammered Martellato | | 48/A/12 | 48/A/11 | - | - | - | - | - |



1466/12

brass-ottone



| Sec.Sez. | Finish - Finitura | | Art. | Art. |
|---------------------|-------------------|--|--------|--------|
| \varnothing 12 mm | Plain Liscio | | 1149/1 | 1149/2 |



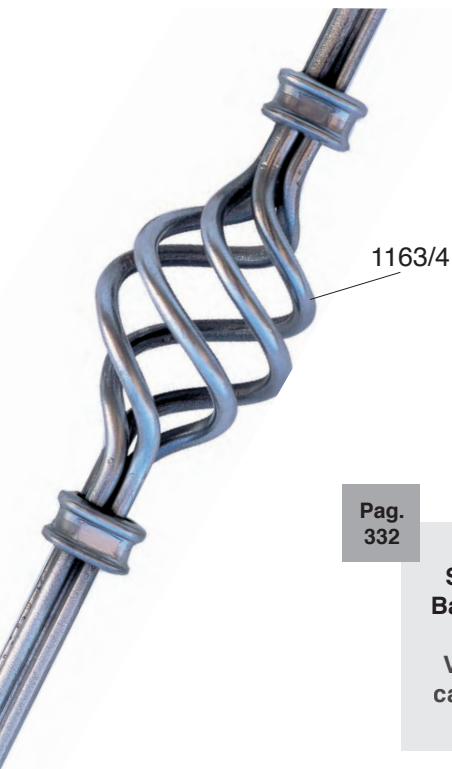

1163/4



Pag.
332

See also the
Basket section

Vedi anche il
capitolo Pigne



H 1000 mm H 1000 mm

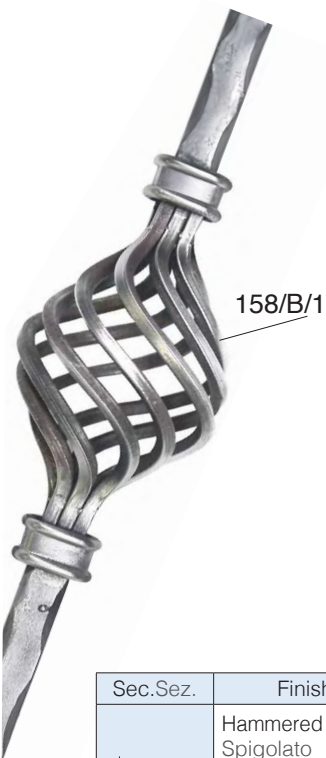

| Sec.Sez. | Finish - Finitura | Art. | Art. |
|----------|---|--------|--------|
| Ø 12 mm | Four-leaf clover Quadrifoglio  | - | 1150/2 |
| Ø 14 mm | Four-leaf clover Quadrifoglio  | 1150/5 | - |



158/B/1



H 900 mm H 900 mm H 900 mm H 900 mm

| Sec.Sez. | Finish - Finitura | Art. | Art. | Art. | Art. |
|----------|--|--------|--------|--------|--------|
| Ø 12 mm | Hammered Spigolato  | 48/B/2 | 48/B/1 | - | - |
| | Hammered Martellato  | - | - | 48/B/8 | 48/B/7 |

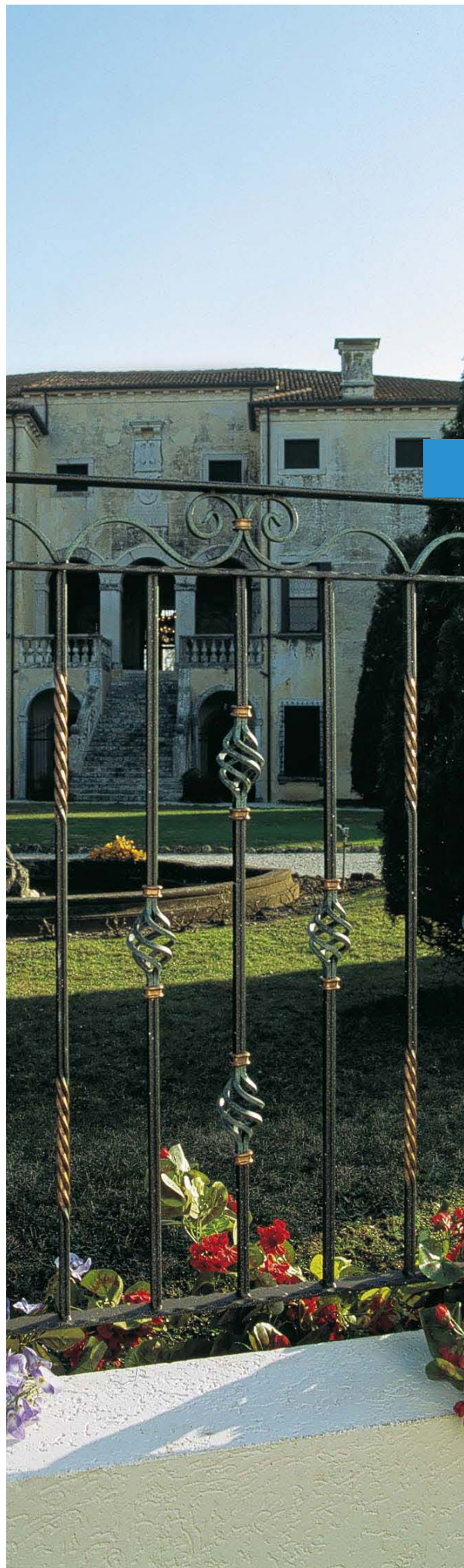





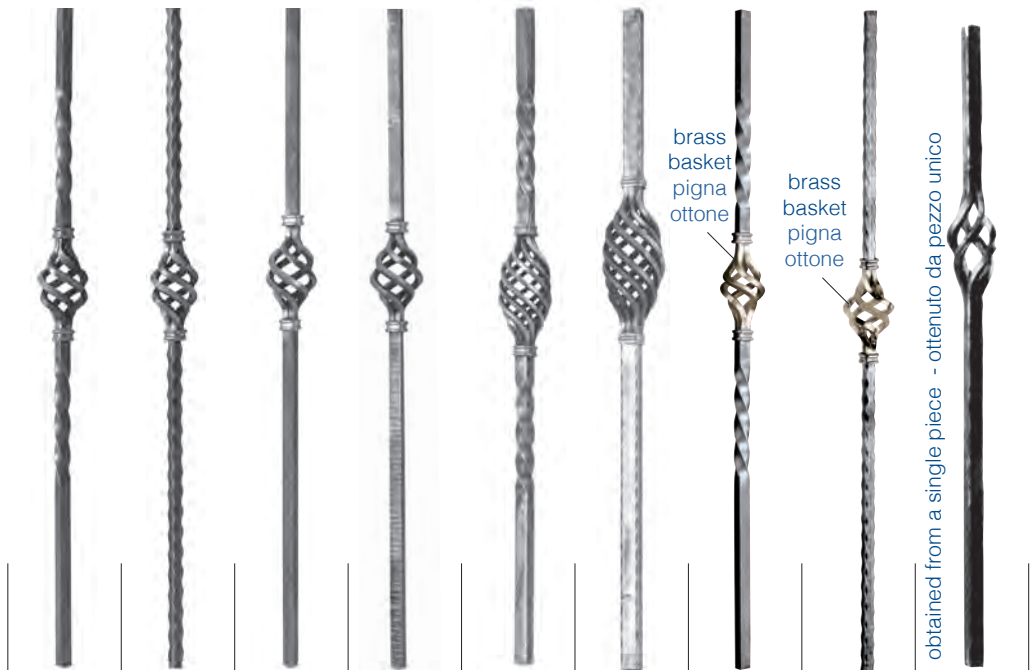

Arteferro products can be manufactured as well as customised.

I prodotti Arteferro sono realizzabili anche su misura.



obtained from a single piece - ottenuto da pezzo unico

| Sec.Sez. | Finish - Finitura | H 1100 mm | | H 1100 mm | | H 1100 mm | | H 1100 mm | | H 1100 mm | | H 1200 mm | | H 1200 mm | |
|----------|---|-----------|-------|-----------|----------|-----------|----------|-----------|--------|-----------|------|-----------|------|-----------|--|
| | | Art. | Art. | Art. | Art. | Art. | Art. | Art. | Art. | Art. | Art. | Art. | Art. | | |
| Φ 20 mm | Plain Liscio  | 113/1 | - | 112/B/9 | - | 112/B/15 | - | 1149/7 | - | - | - | - | - | | |
| | Hammered Spigolato  | - | 113/3 | - | - | - | - | - | 1149/8 | - | - | - | | | |
| Φ 25 mm | Plain Liscio  | - | - | - | - | - | - | - | - | - | - | 112/1 | | | |
| Φ 30 mm | Plain Liscio  | 113/2 | - | 112/B/10 | - | 112/B/16 | - | - | - | - | - | - | | | |
| | Hammered Spigolato  | - | 113/4 | - | - | - | 112/B/14 | - | - | - | - | - | | | |
| | Hammered Martellato  | - | - | - | 112/B/12 | - | - | - | - | - | - | - | | | |



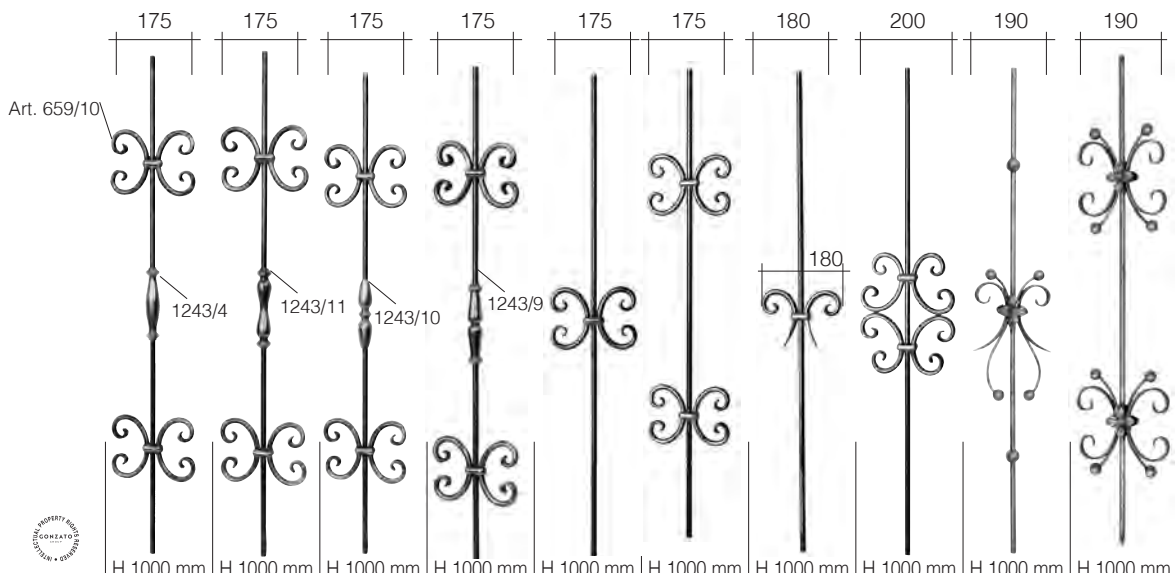

| Sec.Sez. | Finish - Finitura | Art. | Art. | Art. | Art. | Art. | Art. | Art. | Art. | Art. | Art. |
|----------|-------------------|--------|--------|--------|--------|--------|--------|--------|--------|--------|--------|
| Ø 12 mm | Plain Liscio | 1068/1 | 1068/2 | 1068/3 | 1068/4 | 1066/1 | 1066/2 | 1066/3 | 1066/6 | 1060/3 | 1061/2 |

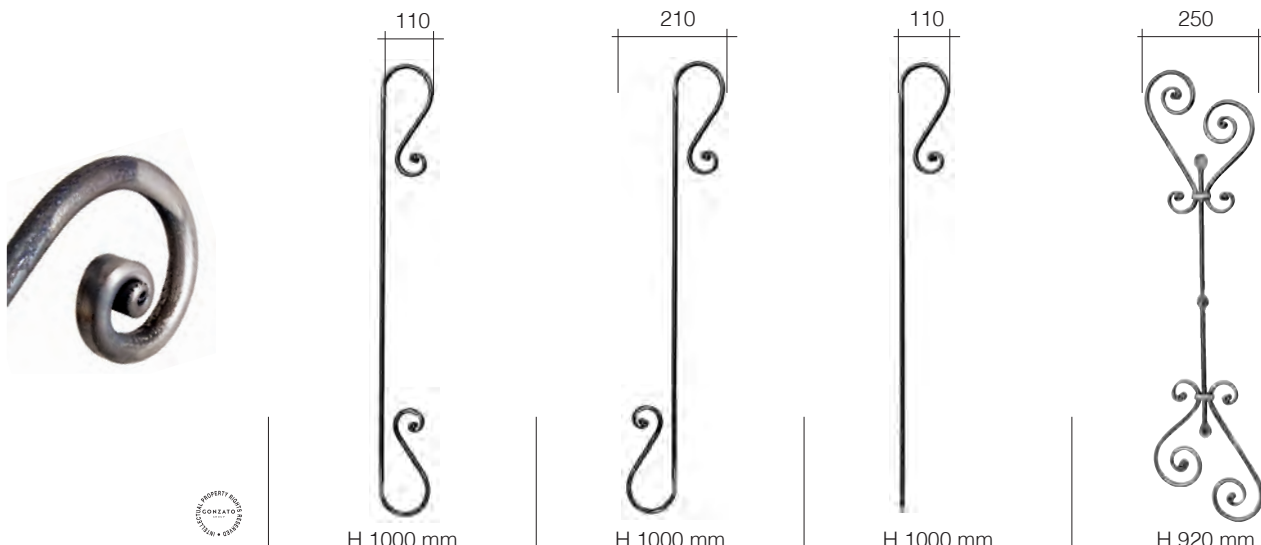

| Sec.Sez. | Finish - Finitura | Art. | Art. | Art. | Art. |
|----------|-------------------|--------|--------|--------|--------|
| Ø 12 mm | Plain Liscio | 1071/3 | 1071/4 | 1071/5 | 1071/1 |



Art. 1292/3
Ø 10 mm
230 x 900 mm





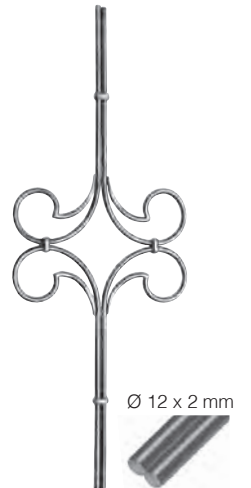
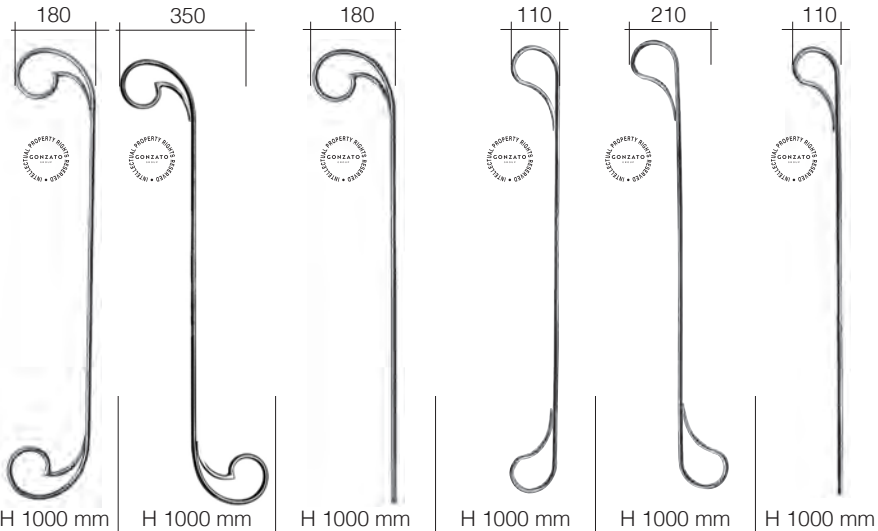

Art. 1053/2
Ø 12 mm
180 x 270 mm

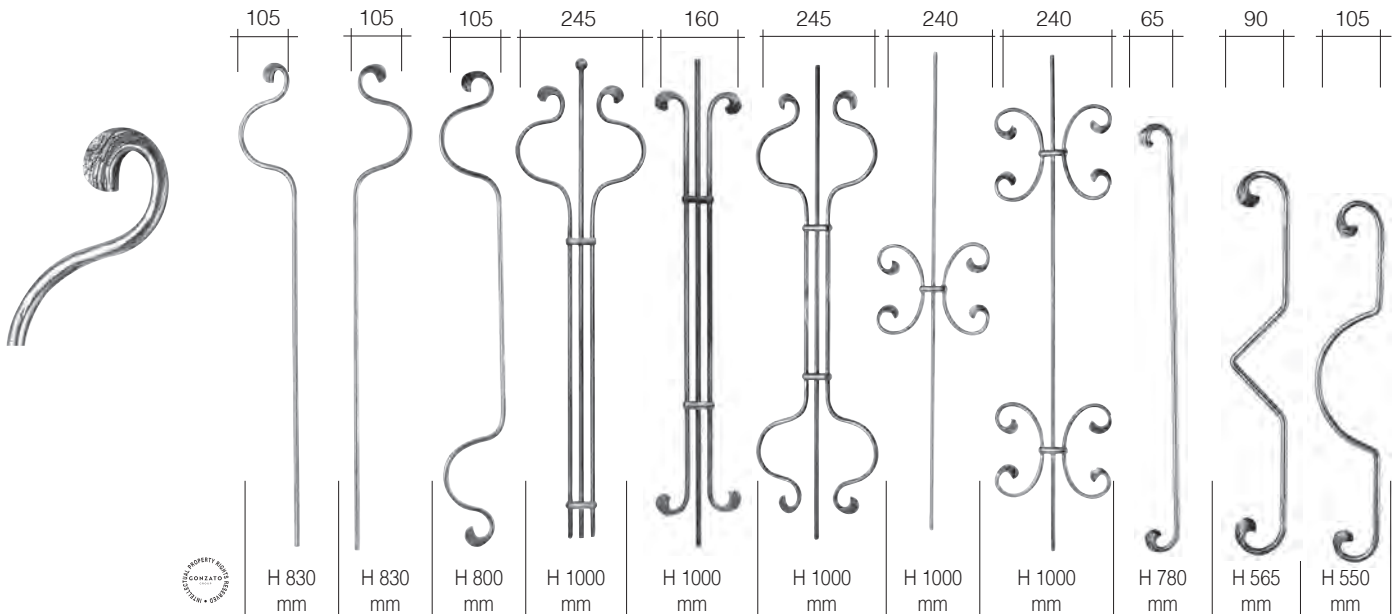

Art. 1053/1
Ø 24 x 12 mm
360 x 1000

| Sec. Sez. | Finish - Finitura | Art. | Art. | Art. | Art. | Art. | Art. |
|-----------|--|--------|--------|--------|--------|--------|--------|
| Ø 12 mm | Plain Liscio  | 1054/1 | 1054/2 | 1054/3 | 1054/4 | 1054/5 | 1054/6 |



| Sec. Sez. | Finish Finitura | Art. | Art. | Art. | Art. | Art. | Art. | Art. | Art. | Art. | Art. | |
|-----------|--|--------|--------|--------|--------|--------|--------|--------|--------|--------|--------|--------|
| Ø 10 mm | Plain Liscio  | 1303/1 | 1303/2 | 1303/3 | 1075/1 | 1073/3 | 1075/2 | 1073/1 | 1073/2 | 1303/4 | 1303/5 | 1303/6 |



| Sec.Sez. | Finish - Finitura | Art. | Art. | Art. | Art. | Art. | Art. | Art. |
|----------|--|-------|------|------|-------|-------|-------|-------|
| Ø 8 mm | Plain Liscio  | 586/3 | 56/1 | 56/6 | 466/2 | 467/1 | 468/1 | 469/1 |

| Sec.Sez. | Finish - Finitura | Art. | Art. | Art. | Art. | Art. |
|----------|--|-------|-------|-------|-------|-------|
| Ø 8 mm | Plain Liscio  | 465/1 | 466/1 | 468/3 | 468/4 | 468/2 |

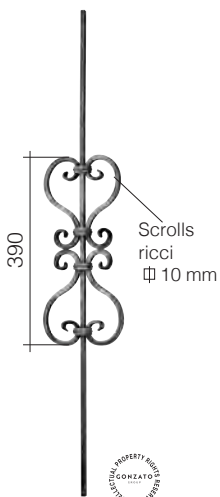

Art. 1125/2
Ø 10 x 10 mm
175 x 1000 mm

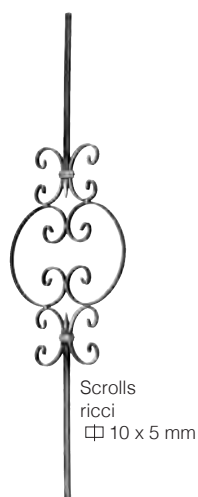

Art. 134/F/4
Ø 10 x 10 mm
250 x 900 mm

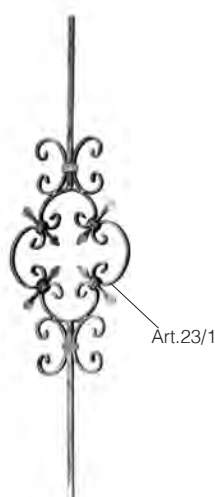

Art. 134/F/3
Ø 10 x 10 mm
250 x 900 mm



Art. 134/G/1
Ø 12 x 12 mm
140 x 900 mm



Art. 134/G/2
Ø 12 x 12 mm
140 x 900 mm

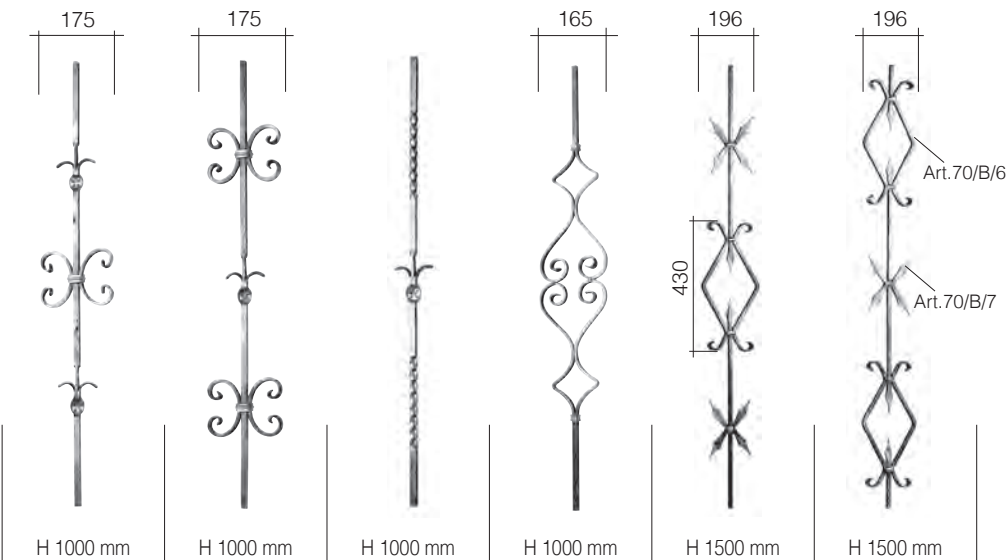

| Sec.Sez. | Finish - Finitura | Art. | Art. | Art. | Art. | Art. | Art. |
|----------|--|--------|--------|--------|--------|--------|--------|
| Ø 12 mm | Plain Liscio  | 1130/1 | 1130/2 | 1130/5 | 1127/4 | 70/B/3 | 70/B/5 |

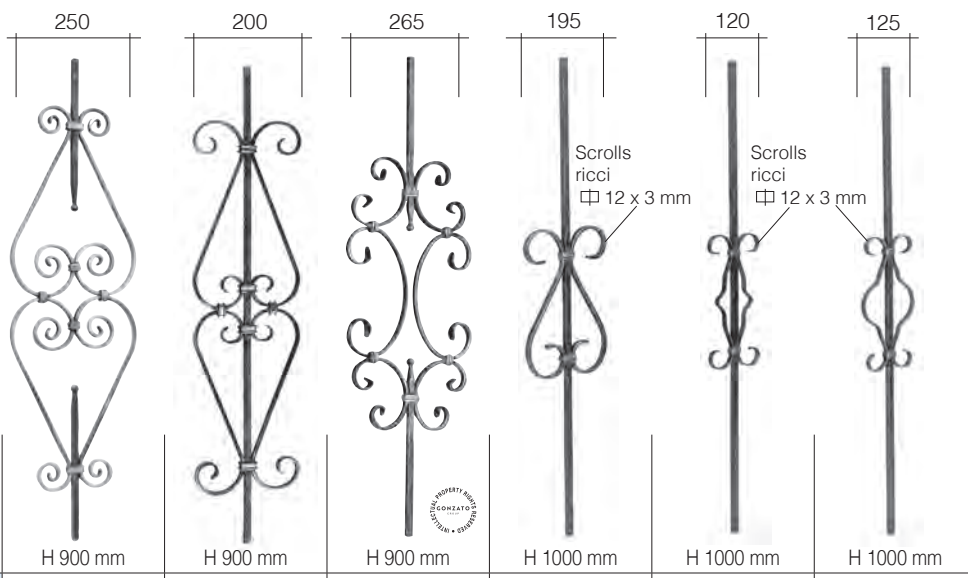

| Sec.Sez. | Finish - Finitura | Art. | Art. | Art. | Art. | Art. | Art. |
|----------|--|------|---------|-------|--------|--------|--------|
| Ø 12 mm | Plain Liscio  | 49/1 | 584/B/4 | 584/3 | 1128/2 | 1128/3 | 1128/5 |



Art. 584/A/2
Ø 12 x 12 mm
180 x 900 mm



Art. 584/A/3
Ø 12 x 12 mm
180 x 900 mm

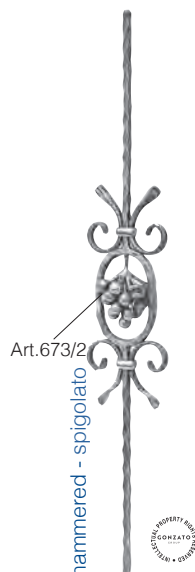

Art. 570/1
Ø 12 x 12 mm
140 x 900 mm



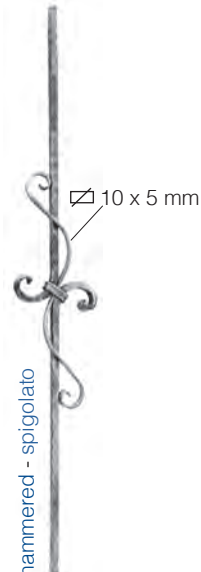

Art. 70/A/3
Ø 12 x 12 mm
130 x 1200 mm

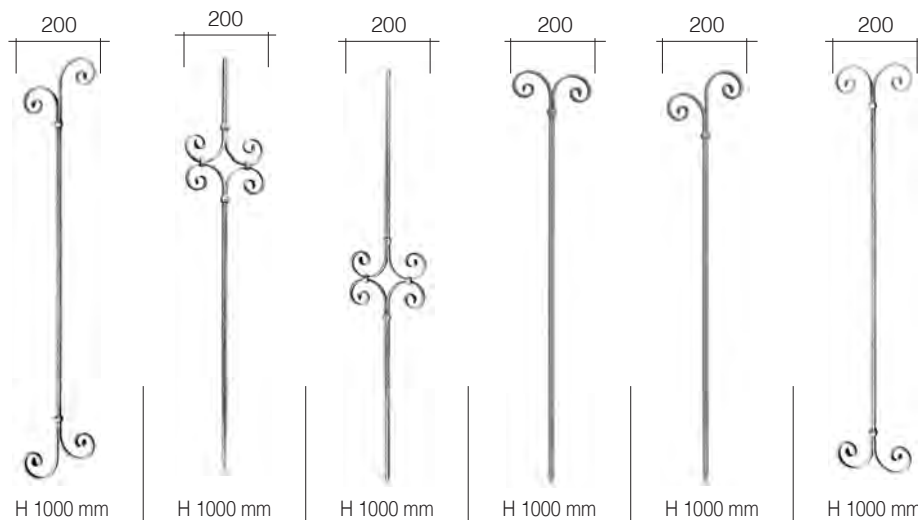

Art. 49/4
Ø 12 x 12 mm
125 x 900 mm



| Sec.Sez. | Finish - Finitura | Art. | Art. | Art. | Art. | Art. | Art. |
|----------|--|---------|---------|---------|--------|--------|--------|
| ∅ 12 mm | Grooved Rigato   | 1695/10 | 1695/11 | 1695/12 | 1695/7 | 1695/8 | 1695/9 |



Art. 1122/3
∅ 12 x 12 mm
180 x 1000 mm



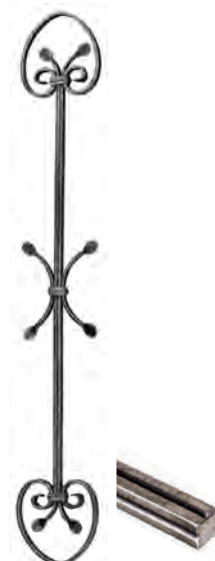

Art. 1122/2
∅ 12 x 12 mm
140 x 1000 mm

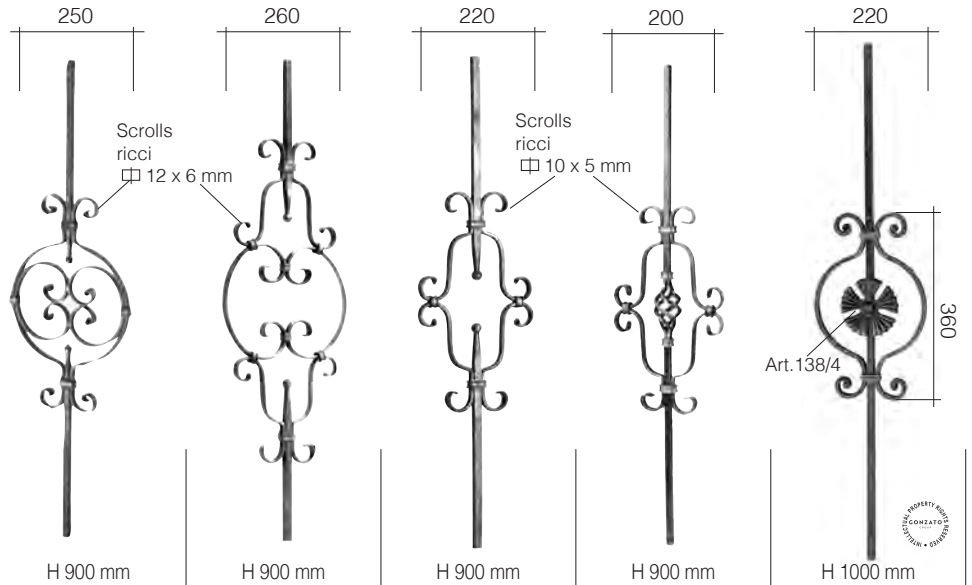

Art. 1122/1
∅ 12 x 12 mm
140 x 1000 mm



| Sec.Sez. | Finish - Finitura | Art. | Art. | Art. | Art. | Art. |
|----------|--|--------|--------|--------|--------|--------|
| ∅ 12 mm | Plain Liscio  | 64/A/1 | 64/A/2 | 64/A/4 | 64/B/1 | - |
| ∅ 14 mm | Plain Liscio  | - | 64/A/6 | - | 64/B/4 | 1126/2 |

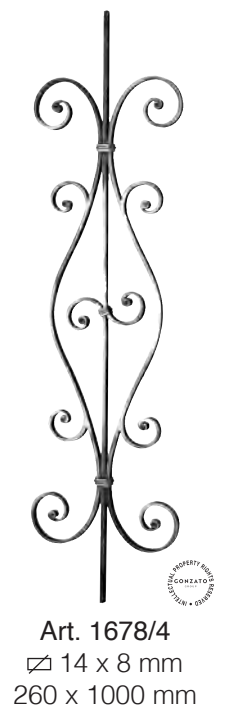

hammered - spigolato



Art. 479/1
Ø 12 x 12 mm
110 x 1000 mm

plain - liscio



Art. 1641/3
Ø 12 x 12 mm
110 x 1000 mm
Art. 1641/4
Ø 14 x 14 mm
110 x 1000 mm

plain - liscio



Art. 1657/2
Ø 16 x 8 mm
110 x 1000 mm

plain - liscio



Art. 1657/3
Ø 16 x 8 mm
110 x 1000 mm





Art. 1032/1
Ø 12 x 12 mm
190 x 1000 mm

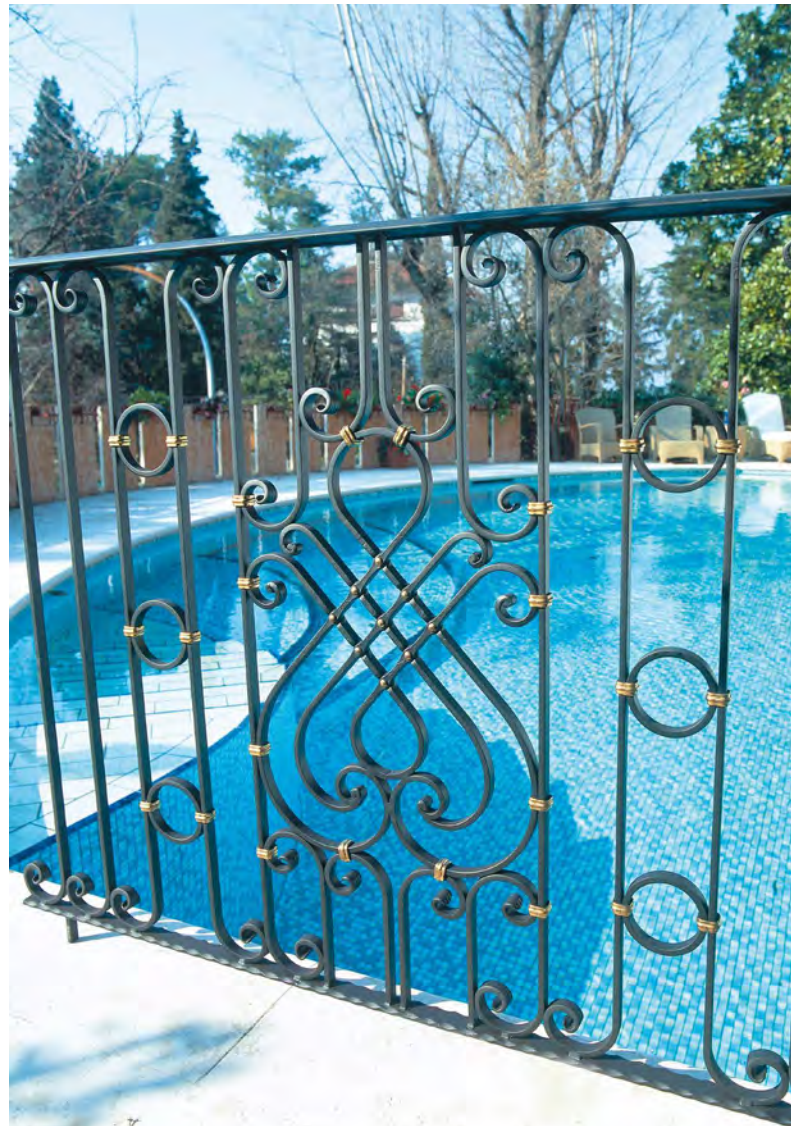

Art. 1043/1
Ø 12 x 12 mm
210 x 1000 mm

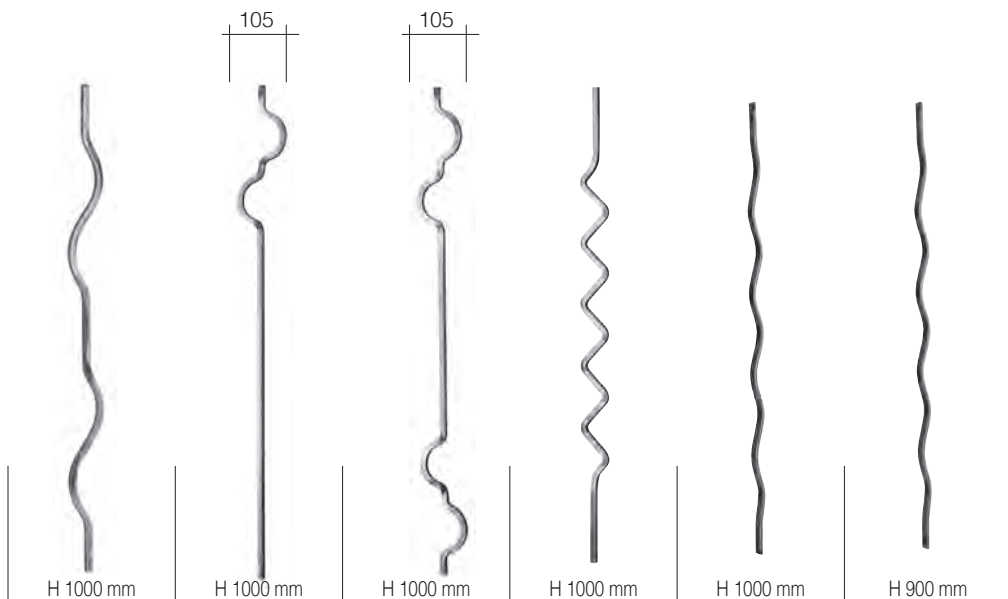



| Sec.Sez. | Finish - Finitura | Art. | Art. | Art. | Art. | Art. | Art. |
|----------|--|---------|--------|--------|---------|-------|--------|
| ∅ 12 mm | Plain Liscio  | 134/G/4 | 1115/1 | 1115/2 | 1133/25 | - | - |
| ∅ 14 mm | Plain Liscio  | - | - | - | - | 597/4 | 70/D/1 |



Art. 1056/10

Art. 1056/10
Fast installation by just a small welding, thanks to a cut off on the edge

Art. 1056/10
Installazione veloce con una piccola saldatura, grazie alla sezione troncata



NEW



Art. 1056/10
∅ 12 x 12 mm
125 x 1000 mm





twist - Attorcigliatura

H 1000 mm



H 1000 mm



H 1000 mm



twist - Attorcigliatura

H 1000 mm



twist - Attorcigliatura

H 1000 mm

| Sec.Sez. | Finish - Finitura | Art. | Art. | Art. | Art. | Art. |
|----------|--|--------|--------|--------|--------|--------|
| ∅ 12 mm | Grooved Rigato  | 1055/4 | 1055/5 | 1056/1 | 1056/2 | 1056/4 |

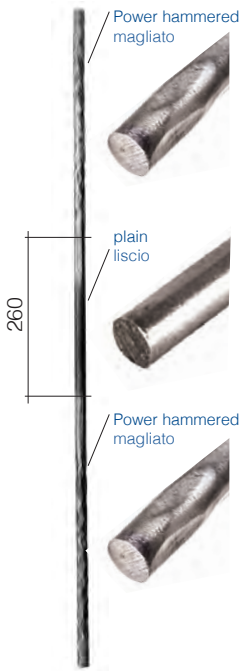

Art. 595/12
Ø 12 mm
H 900 mm



Art. 602/15
Ø 14 mm
H 1200 mm
Art. 602/18
Ø 20 mm
H 1200 mm



Art. 601/2
Ø 12 mm
H 900 mm
Art. 601/8
Ø 12 mm
H 1000 mm
Art. 601/10
Ø 16 mm
H 1000 mm



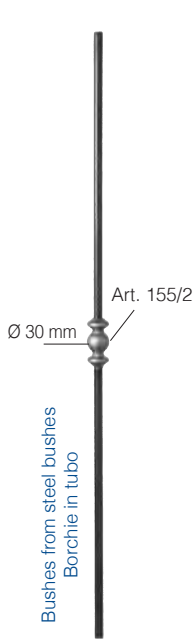

Art. 150/3
Ø 12 mm
H 900 mm

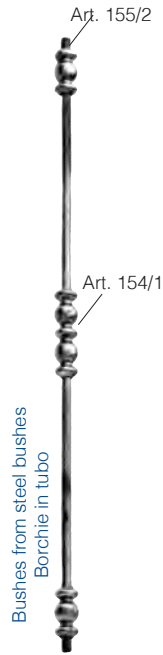

Art. 154/6
Ø 12 mm
H 830 mm

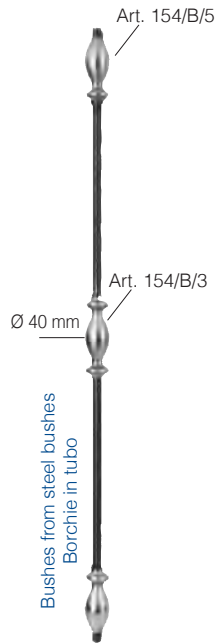

Art. 154/B/7
Ø 14 mm
H 720 mm

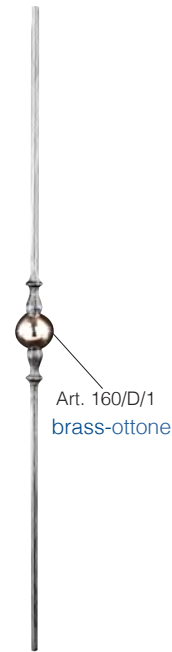

Art. 518/1
H 900 mm

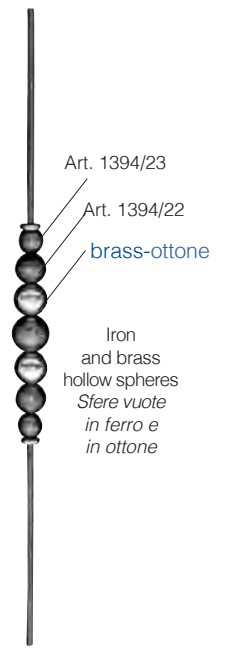

Art. 1211/4
Ø 12 mm
H 1000 mm



Art. 570/4
Ø 14 x 14 mm
100 x 900 mm



Art. 1067/2
Ø 12 mm
H 1000 mm



Art. 1067/3
Ø 12 mm
175 x 1000 mm



Art. 160/C/1
Ø 20 x 20 mm
130 x 900 mm



Art. 61/3
plain/liscio
Ø 40 x 4 mm
125 x 900 mm



Art. 1081/4
Ø 10 mm
220 x 1000 mm



Art. 1080/7
Ø 12 mm
124 x 1000 mm

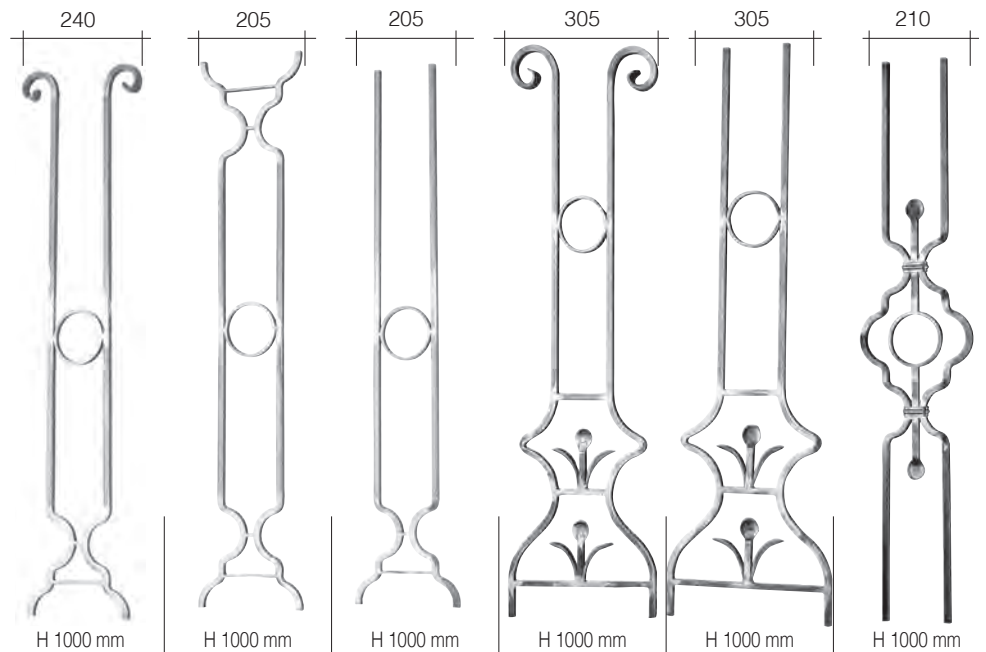
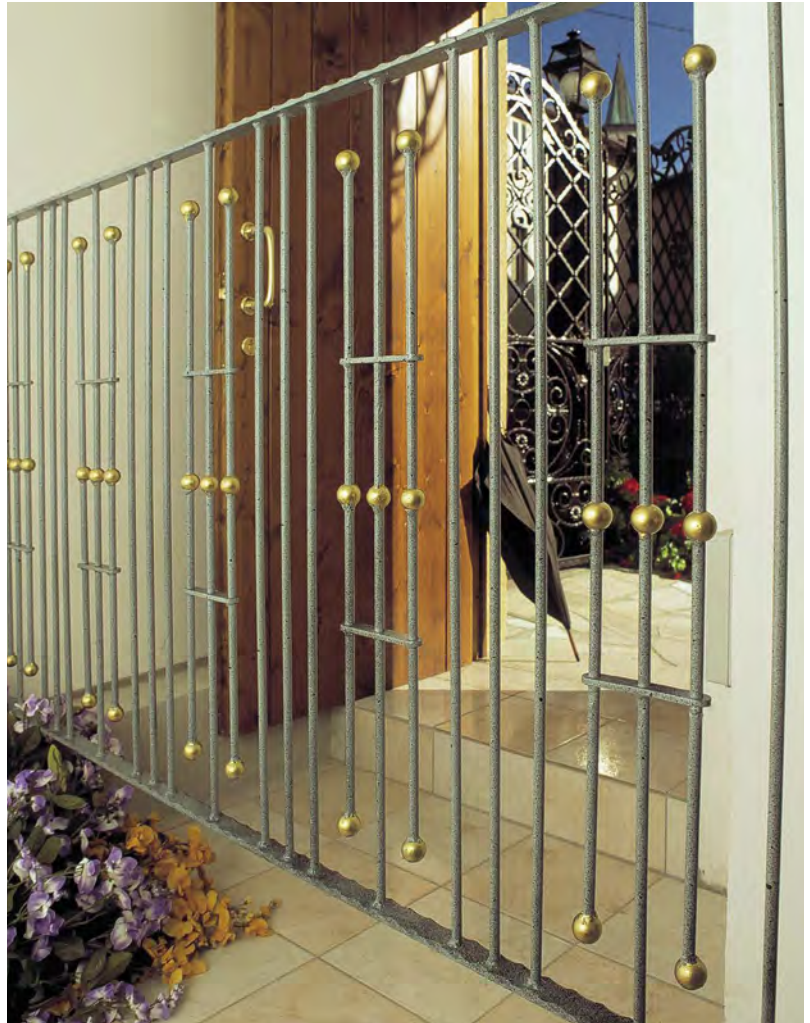

| Sec.Sez. | Finish - Finitura | Art. | Art. | Art. | Art. | Art. | Art. |
|----------|---|--------|--------|--------|--------|--------|--------|
| Ø 12 mm | Plain Liscio  | 1111/1 | 1111/2 | 1111/3 | 1097/1 | 1097/2 | 1105/1 |



Art. 1142/1
Ø 12 x 12 mm
180 x 1000 mm



Art. 1142/2
Ø 12 x 12 mm
280 x 1000 mm



Art. 1741/3
Ø 12 x 12 mm
280 x 1000 mm



Rosette | 1/6/A/4 sui due lati - Rosettes | 1/6/A/4 on both sides



Art. 1685/1
Ø 14 x 14 mm
245 x 1000 mm

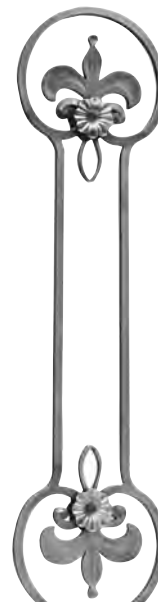

Rosette | 1/6/A/4 sui due lati - Rosettes | 1/6/A/4 on both sides



Art. 1685/2
Ø 14 x 14 mm
245 x 1000 mm



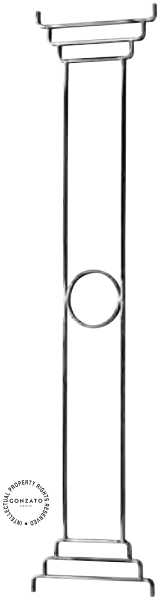

Art. 1118/1
12 x 6 mm
215 x 1000 mm

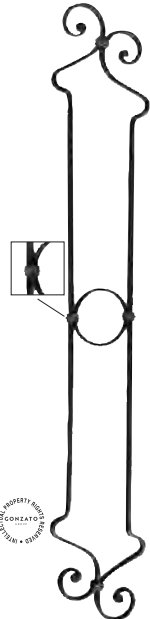

Art. 1672/1
14 x 8 mm
175 x 1000 mm

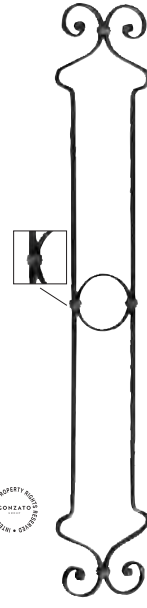

Art. 1672/2
14 x 8 mm
175 x 1000 mm

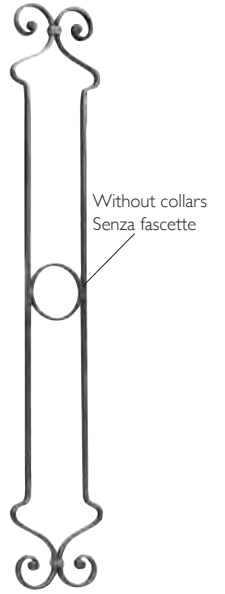

Art. 1674/2
14 x 8 mm
175 x 1000 mm



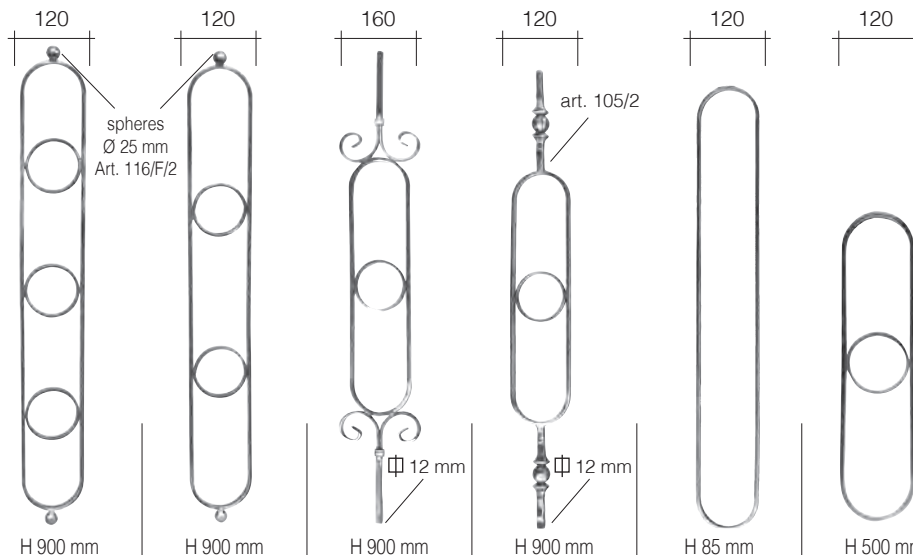

| Sec.Sez. | Finish - Finitura | Art. | Art. | Art. | Art. | Art. | Art. |
|-------------|-------------------|-------|-------|-------|-------|-------|-------|
| ☒ 14 x 8 mm | Plain Liscio | 544/1 | 544/2 | 548/2 | 555/1 | 543/1 | 543/3 |

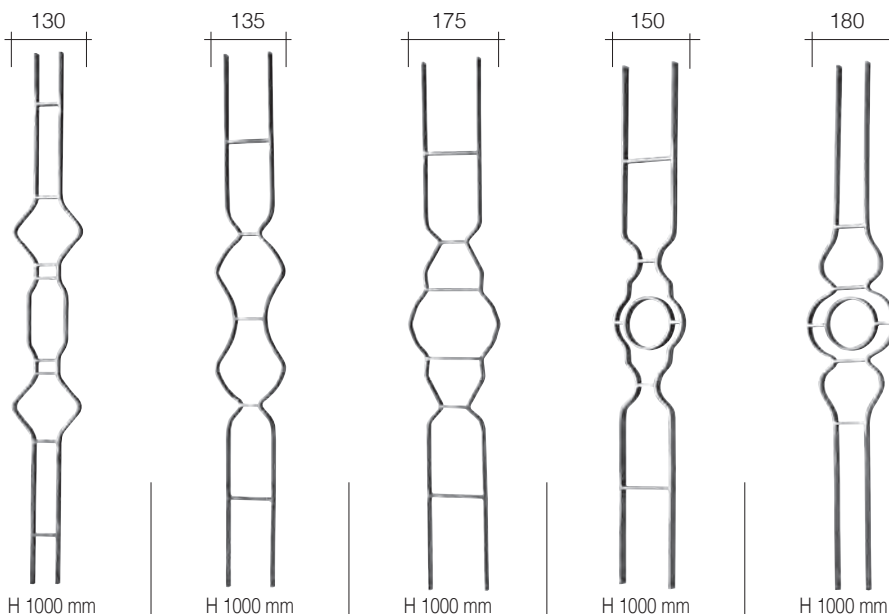

| Sec.Sez. | Finish - Finitura | Art. | Art. | Art. | Art. | Art. |
|-------------|-------------------|--------|--------|--------|--------|--------|
| ☒ 20 x 6 mm | Plain Liscio | 1117/1 | 1117/2 | 1117/3 | 1116/3 | 1116/4 |



Art. 1116/1
☒ 20 x 8 mm
265 x 1000 mm



Art. 1116/2
☒ 20 x 8 mm
245 x 1000 mm



Art. 1101/1
☒ 20 x 8 mm
240 x 1000 mm



Art. 670/4
Ø 12 mm
320 x 520 mm



Art. 673/2
Ø 12 mm
300 x 500 mm



Art. 671/1
Ø 12 mm
315 x 390 mm



Art. 671/2
Ø 12 mm
315 x 390 mm



Art. 671/3
Ø 12 mm
420 x 490 mm



Art. 671/4
Ø 12 mm
420 x 490 mm



Art. 678/1
Ø 12 mm
75 x 510 mm

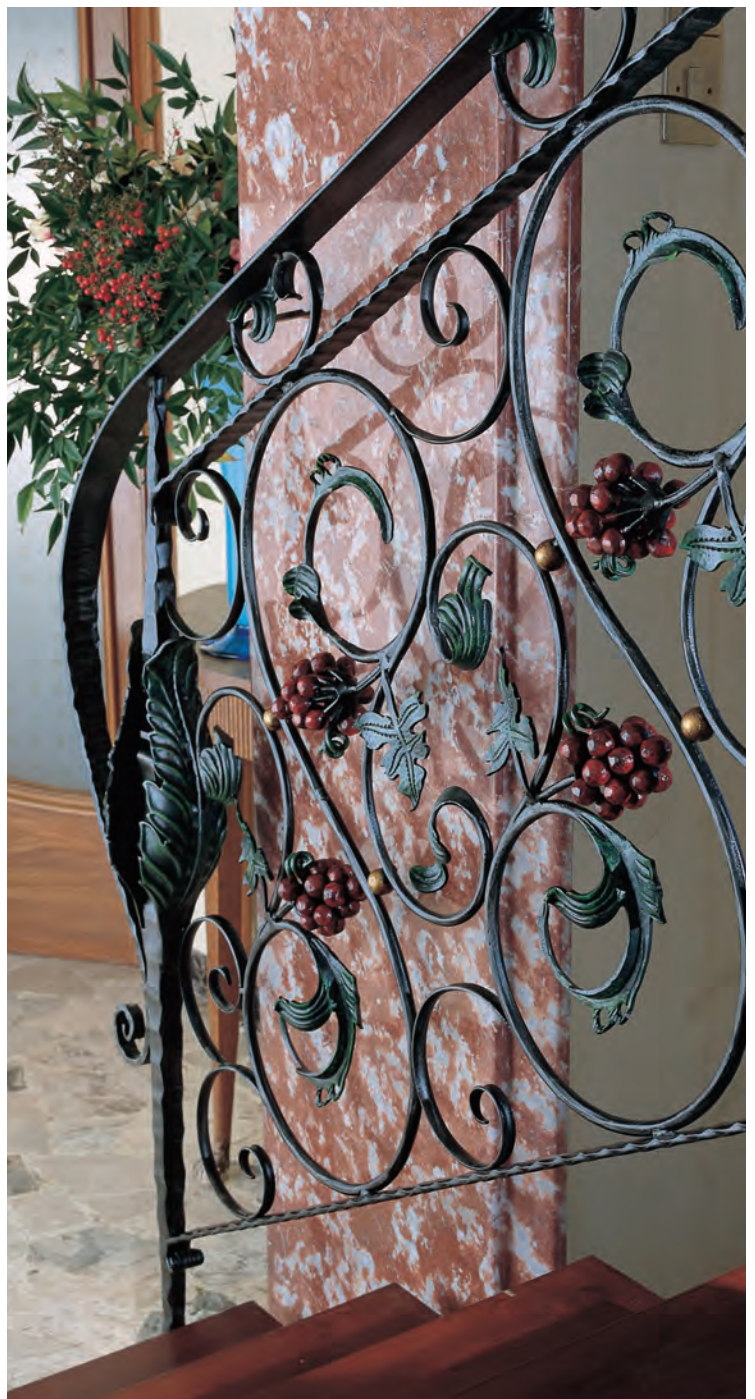

* Scrolls with forged ends - Riccioli con terminali fucinati

Rosettes 126/3 on both sides
Rosette 126/3 sui 2 lati



Art. 24/F/1
Φ 12 x 12 mm
300 x 560 mm



Art. 1050/4
Ø 12 mm
265 x 640 mm



Art. 1050/3
Φ 14 x 14 mm
265 x 720 mm



Art. 540/2
Ø 12 mm
250 x 720 mm



Art. 1050/1
∅ 20 x 6 mm
235 x 720 mm



Art. 62/2
∅ 20 x 6 mm
235 x 720 mm



Art. 63/4
∅ 20 x 6 mm
235 x 820 mm



Art. 1045/7
Φ 12 x 12 mm
250 x 770 mm



Art. 1045/8
Φ 12 x 12 mm
250 x 770 mm



Art. 1045/5
Φ 12 x 12 mm
250 x 770 mm



Art. 1045/6
Φ 12 x 12 mm
250 x 770 mm



Art. 1050/2
Φ 10 x 10 mm
235 x 720 mm



Art. 63/2
∅ 20 x 6 mm
235 x 720 mm



Art. 63/3
∅ 20 x 4 mm
235 x 820 mm



Art. 1046/1
Φ 12 x 12 mm
250 x 900 mm



Art. 1046/2
Φ 12 x 12 mm
200 x 900 mm

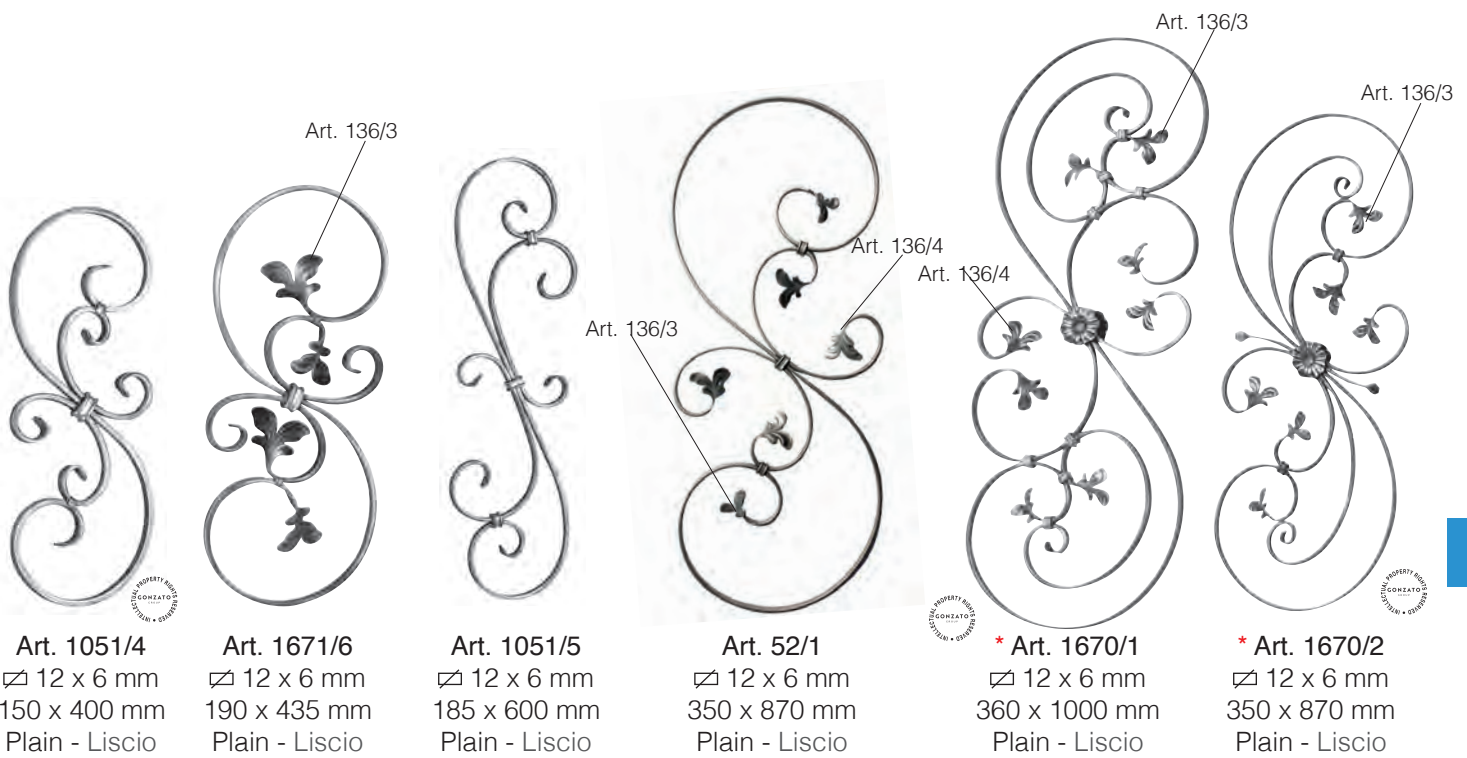

Art. 1051/4
∅ 12 x 6 mm
150 x 400 mm
Plain - Liscio

Art. 1671/6
∅ 12 x 6 mm
190 x 435 mm
Plain - Liscio

Art. 1051/5
∅ 12 x 6 mm
185 x 600 mm
Plain - Liscio

Art. 52/1
∅ 12 x 6 mm
350 x 870 mm
Plain - Liscio

*** Art. 1670/1**
∅ 12 x 6 mm
360 x 1000 mm
Plain - Liscio

*** Art. 1670/2**
∅ 12 x 6 mm
350 x 870 mm
Plain - Liscio

*Rosettes 116/A/4 on both sides
*Rosette 116/A/4 sui 2 lati

Pag.
336

Do you need wrought
iron leaves?
Go to section 15
Flowers and Rosettes

Hai bisogno di foglie
in ferro battuto?
Vai al capitolo 15
Fiori e Rosette

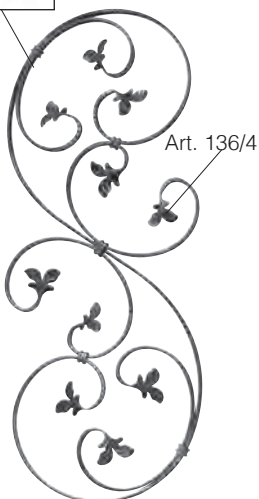

Art. 1671/3
∅ 12 x 6 mm
350 x 870 mm
Notched - Tacchettato



Art. 1671/4
∅ 12 x 6 mm
350 x 870 mm
Hammered - Spigolato



Art. 541/1
∅ 12 x 12 mm
370 x 900 mm
Hammered - Spigolato



Art. 1671/1
∅ 12 x 12 mm
350 x 900 mm
Hammered - Spigolato

Art. 541/2
∅ 14 mm
340 x 900 mm
Plain - Liscio

Art. 1671/2
∅ 12 mm
350 x 900 mm
Plain - Liscio

Hot forged end scrolls - Riccioli terminali fucinati a caldo



Art. 681/2
∅ 16 x 8 mm
270 x 600 mm



Art. 681/1
∅ 16 x 8 mm
270 x 600 mm



Art. 685/4
∅ 12 mm
240 x 590 mm



Art. 685/3
∅ 12 mm
240 x 590 mm



Art. 685/2
∅ 12 mm
320 x 740 mm



Art. 685/1
∅ 12 mm
320 x 740 mm



Art. 681/3
∅ 16 x 8 mm
320 x 740 mm



Art. 681/4
∅ 16 x 8 mm
320 x 740 mm



Art. 682/5
right-*destra*
∅ 16 x 8 mm
300 x 580 mm
Art. 682/4
left-*sinistra*
∅ 16 x 8 mm
300 x 580 mm



Art. 685/6
∅ 12 mm
360 x 810 mm



Art. 685/5
∅ 12 mm
360 x 810 mm





Art. 486/2
16 x 8 mm
300 x 700 mm



Forgiati/Hot forged

Art. 498/1
Ø 12 mm
H 650 mm



Art. 52/E/5
12 x 12 mm
300 x 900 mm

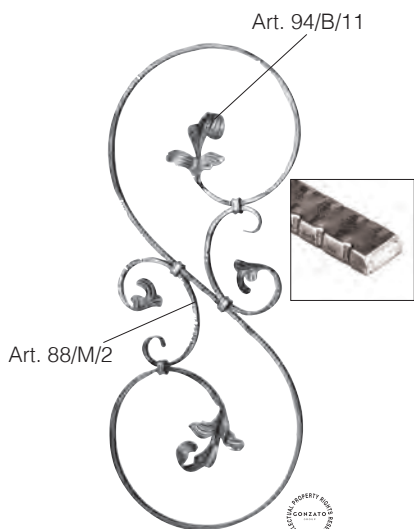

Art. 52/G/1
16 x 8 mm
370 x 870 mm
Notched
Tacchettato



Art. 485/1
Ø 10 mm
370 x 900 mm





Art. 483/1
 Φ 14 x 14 mm
 540 x 1100 mm
 power hammered
 magliato



Art. 697/4 on
both sides
Art. 697/4 su
entrambi i lati

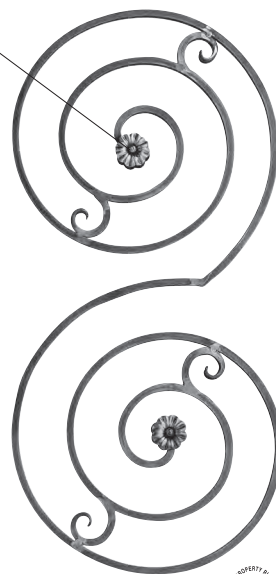

Art. 1038/1
 Φ 14 x 14 mm
 510 x 1080 mm
 plain - liscio



Newel Post - Caposaldo



Art. 1206/1
 Φ 30 x 30 mm
 H 1200 mm
 L 270 mm



Art. 802/2
 \square 25 x 12 mm
 H 650 mm
 L 270 mm





Art. 1049/1
Ø 14 mm
260 x 1000 mm

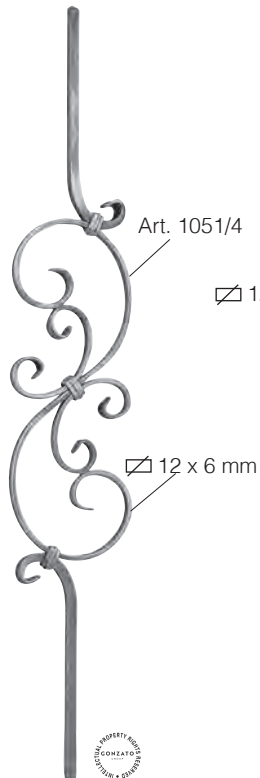

Art. 1051/2
Ø 12 x 12 mm
150 x 1000 mm

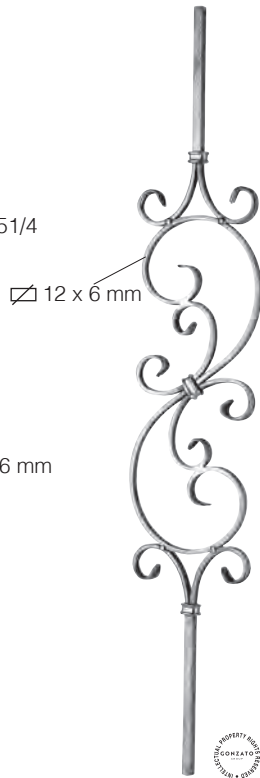

Art. 1051/3
Ø 12 x 12 mm
150 x 1000 mm



Art. 52/E/1
Ø 12 x 12 mm
180 x 900 mm
hammered - spigolato



Art. 52/A/4
Ø 12 x 12 mm
250 x 900 mm



Art. 1051/1
Ø 12 x 12 mm
185 x 1000 mm



Art. 659/10



Hollow spheres - Sfere vuote
Ø 30 mm - Ø 40 mm



Art. 1064/3
Ø 12 mm
200 x 1000 mm



Art. 138/15

Art. 49/2
Ø 12 x 12 mm
165 x 900 mm
hammered - spigolato



Art. 539/2
Ø 12 x 12 mm
190 x 900 mm

676/2 on both sides - sui 2 lati



Art. 487/1
Ø 16 x 8 mm
230 x 900 mm



Art. 488/1
Ø 16 x 8 mm
190 x 900 mm

Rosette 116/A/4 on both sides - sui 2 lati

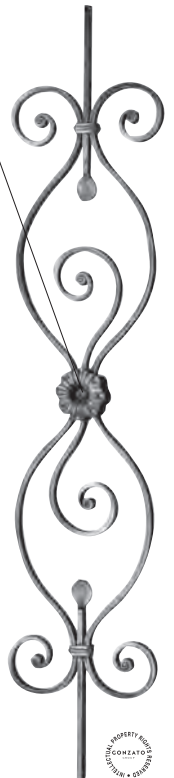

Art. 1678/2
Ø 14 x 8 mm
205 x 1000 mm



Art. 51/3
Ø 12 x 12 mm
300 x 900 mm

Art. 51/6
Ø 14 x 14 mm
300 x 900 mm

Art. 1753/4
Ø 12 x 12 mm
300 x 1000 mm

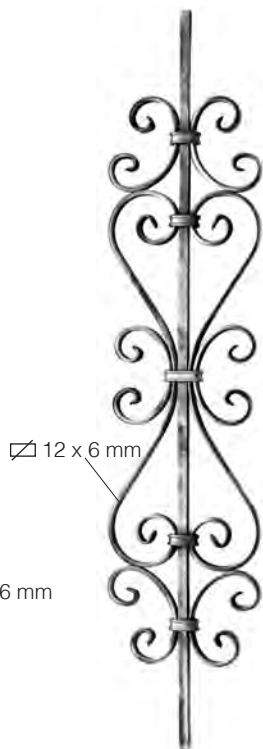

Art. 52/E/2
Ø 12 x 12 mm
185 x 900 mm



Art. 510/1
Ø 12 x 12 mm
250 x 900 mm



Art. 511/1
Ø 12 x 12 mm
125 x 900 mm





Art. 68/2
∅ 8 x 8 mm
250 x 720 mm



Art. 58/1
∅ 8 x 8 mm
270 x 800 mm



Art. 64/2
∅ 8 x 8 mm
140 x 850 mm



Art. 471/1
∇ 14 x 8 mm
250 x 900 mm

Pag.
276

In section 11,
scrolls and Snap-ons
you'll find many items
to match

Nel capitolo 11
Ricci e Snap-ons
troverai tanti
elementi da abbinare



Art. 453/8
∇ 12 x 6 mm
180 x 480 mm

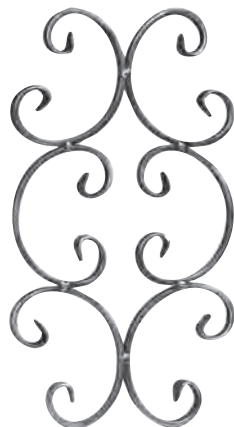

Art. 453/9
∇ 12 x 6 mm
220 x 405 mm



Art. 59/1
∇ 20 x 4 mm
170 x 830 mm



Art. 59/8
∇ 20 x 4 mm
175 x 820 mm



Art. 59/3
∇ 20 x 4 mm
175 x 720 mm



Art. 64/B/3
Ø 12 x 12 mm
255 x 900 mm



Art. 65/1
Ø 12 x 12 mm
160 x 820 mm



Art. 70/E/2
Ø 12 x 12 mm
H 820 mm



Art. 70/E/7
Ø 14 x 14 mm
H 820 mm

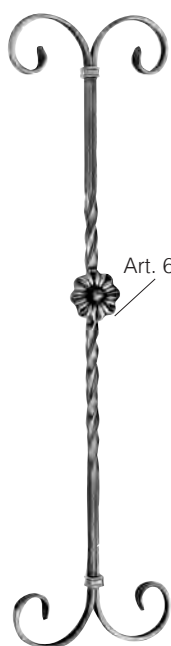

Art. 463/3
12 x 6 mm
210 x 790 mm

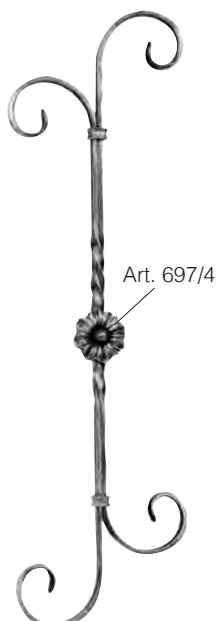

Art. 463/4
12 x 6 mm
210 x 660 mm



Art. 464/1
12 x 12 mm
230 x 900 mm

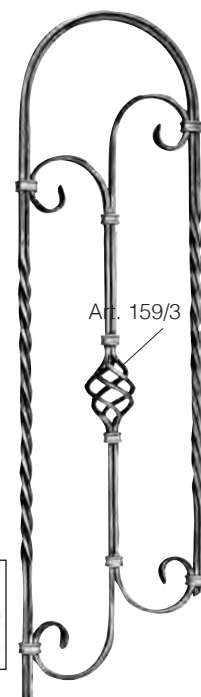

Art. 464/2
12 x 12 mm
230 x 900 mm

Rosette 116/A/4 on both sides - sui 2 lati



Art. 473/1
 \varnothing 12 x 12 mm
 380 x 900 mm
 hammered - spigolato



Art. 474/1
 \varnothing 12 x 12 mm
 380 x 755 mm
 hammered - spigolato

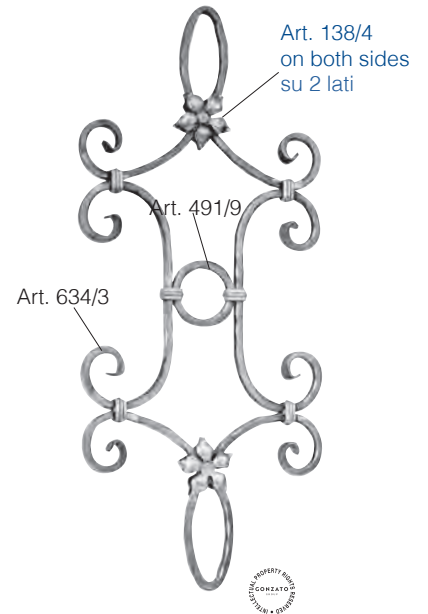

Art. 479/2
 \varnothing 12 x 12 mm
 385 x 900 mm
 hammered - spigolato



Art. 475/1
 \varnothing 12 x 12 mm
 380 x 825 mm
 hammered - spigolato

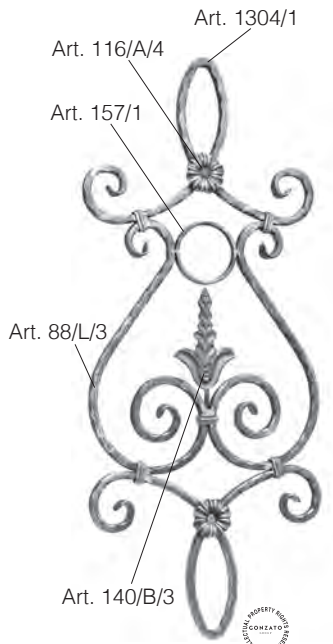

Art. 475/2
 \varnothing 12 x 12 mm
 380 x 900 mm
 hammered - spigolato



Art. 1647/2
 \square 12 x 6 mm
 200 x 500 mm



Art. 1647/3
 \square 12 x 6 mm
 200 x 500 mm

Rosette 116/A/4 on both sides - sui 2 lati





Art. 456/1
Ø 12 x 12 mm
400 x 1020 mm

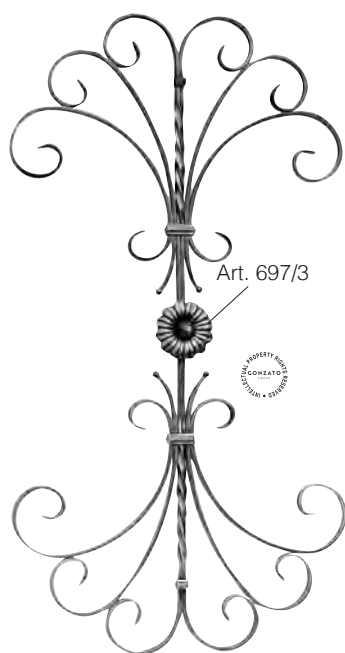

Art. 456/3
Ø 12 x 6 mm
454 x 1020 mm



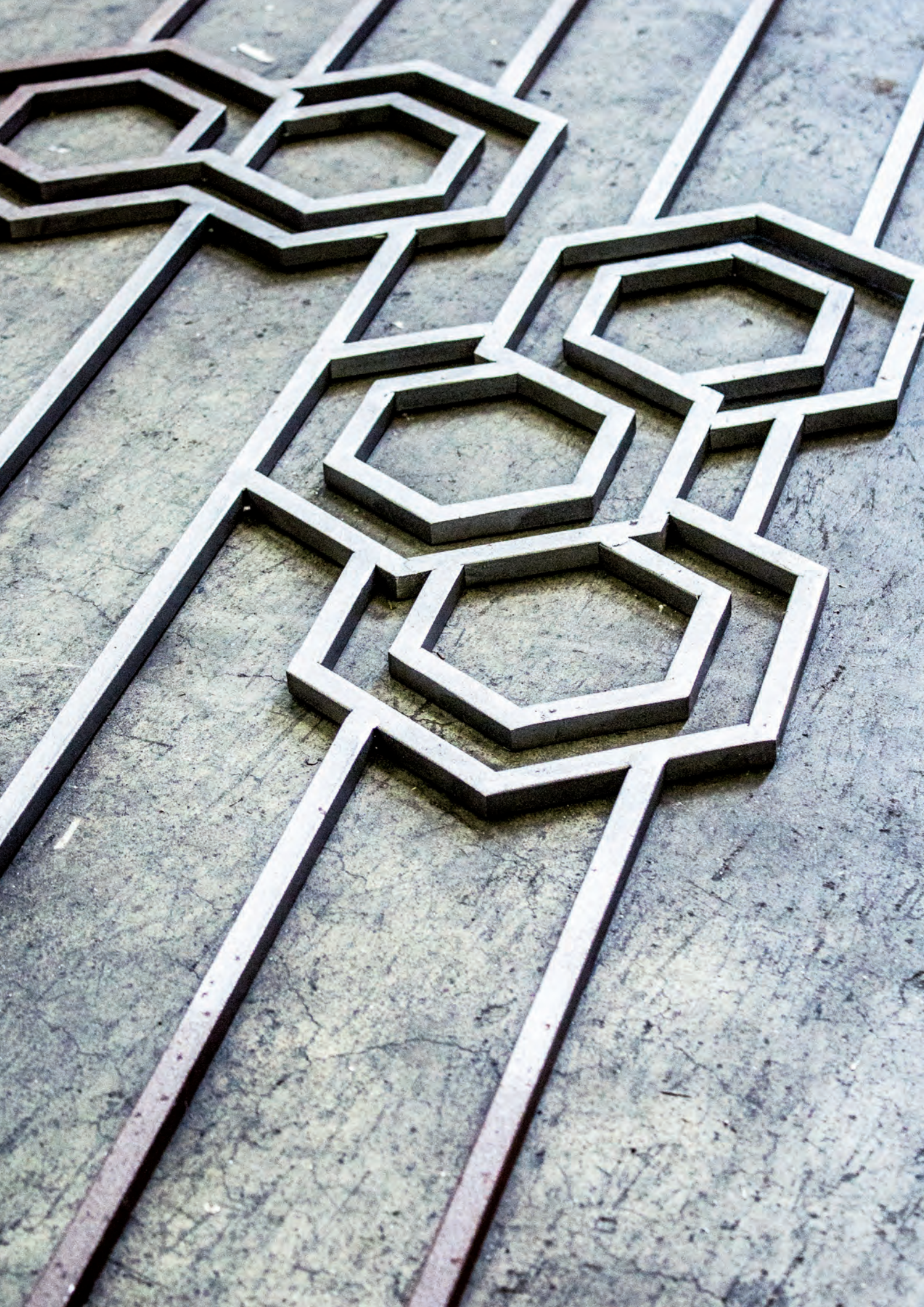

Modern Pickets and Panels

Paletti e Pannelli moderni

Arteferro pickets and panels are amongst the most important items in the composition of an infill of a balustrade or fence. The modern design of these new lines of items reinterprets in a contemporary way, the elegance and refinement of traditional materials like wrought iron.

I paletti e pannelli Arteferro sono tra gli elementi più importanti nella composizione del tamponamento di un parapetto o di una recinzione. Il design moderno di queste nuove linee di elementi reinterpreta in chiave contemporanea l'eleganza e la raffinatezza di un materiale tradizionale come il ferro battuto.

arteferro



5

Modern pickets and Panels
Paletti e Pannelli moderni



- A Geometric Style pag.81
- B Linear Style pag.91
- C Floreal Style pag.103
- D Waves Style pag.108
- E Impero Style pag.112
- F Revolution Style pag.117
- G New Classic Style pag.124
- H New Liberty Style pag.133

Most of the pickets and panels have been classified to make it easier for you to find the item you want quickly and easily. Starting with the central motif you can find your article with its finish and the matching decorations.

Molti paletti e pannelli sono stati classificati per dare la possibilità di trovare in modo veloce e pratico l'articolo desiderato. Parti dal motivo centrale troverai il tuo articolo con la lavorazione e i decori abbinabili.



Art. 1082/4
Ø 10 mm
100 x 1000 mm



Art. 1085/1
Ø 12 mm
112 x 1000 mm



Art. 1085/2
Ø 12 mm
112 x 1000 mm



Art. 1084/1
Ø 12 x 12 mm
175 x 1000 mm



Art. 1084/2
Ø 12 x 12 mm
175 x 1000 mm



Art. GD59/2
 \varnothing 12 x 12 mm
 55 x 1000 mm
 Art. GD59/2/Q14
 \varnothing 14 x 14 mm
 55 x 1000 mm



Art. GD23/1
 \varnothing 14 mm
 120 x 1000 mm
 A = 75 mm
 Art. GD58/3
 \varnothing 12 mm
 120 x 1000 mm
 A = 80 mm

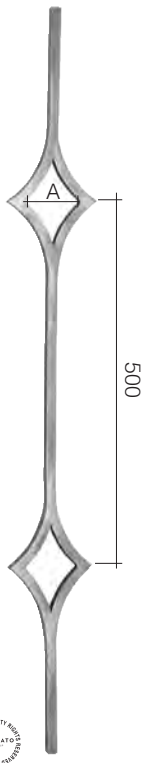

Art. GD25/1
 \varnothing 14 mm
 120 x 1000 mm
 A = 75 mm
 Art. GD58/2
 \varnothing 12 mm
 120 x 1000 mm
 A = 80 mm



Art. GD19/1
 \varnothing 14 x 8 mm
 100 x 1000 mm

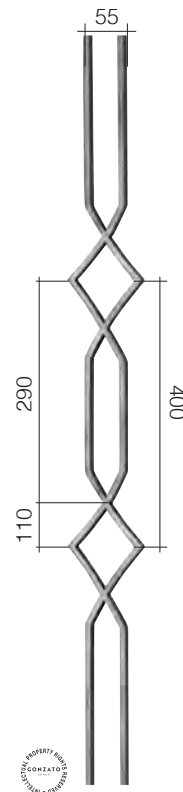

Art. GD19/2
 \varnothing 14 x 8 mm
 100 x 1000 mm

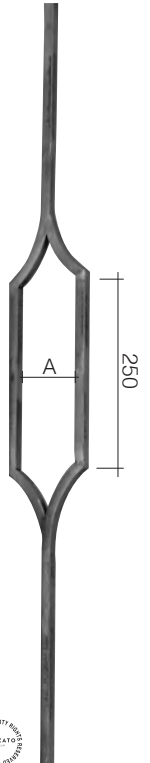

Art. GD25/3
 \varnothing 14 mm
 110 x 1000 mm
 A = 82 mm
 Art. GD243/2
 \varnothing 12 mm
 110 x 1000 mm
 A = 86 mm



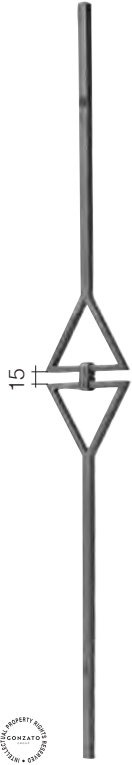

Art. GD181/1
⌀ 14 mm
130 x 1000 mm

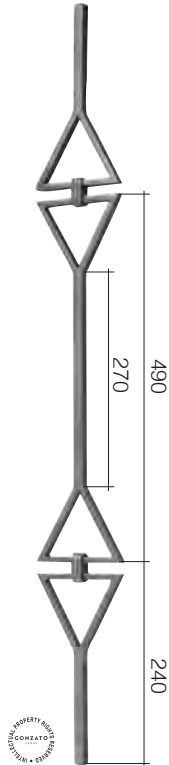
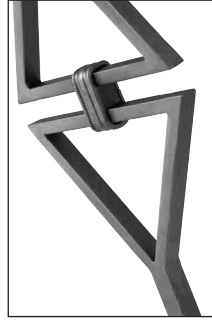

Art. GD181/2
⌀ 14 mm
130 x 1000 mm

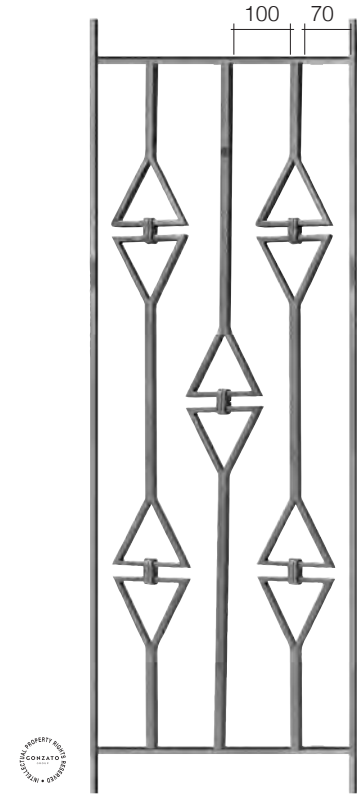

Art. GD181/3
⌀ 14 x 8 mm
400 x 1000 mm

Ornaments - Ornamenti ⌀ 14 x 8 mm

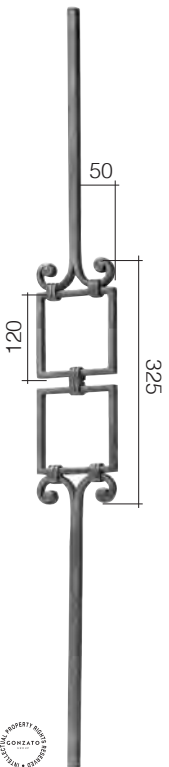

Art. GD184/1
⌀ 14 mm
115 x 1000 mm

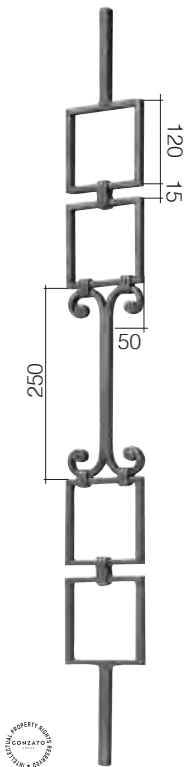

Art. GD184/2
⌀ 14 mm
115 x 1000 mm

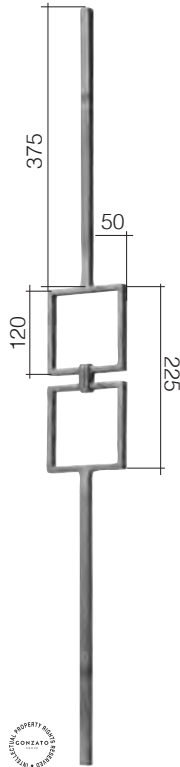

Art. GD182/1
⌀ 14 mm
115 x 1000 mm

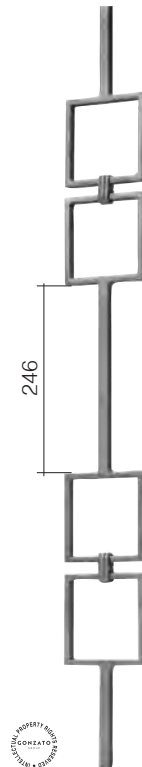

Art. GD182/2
⌀ 14 mm
115 x 1000 mm

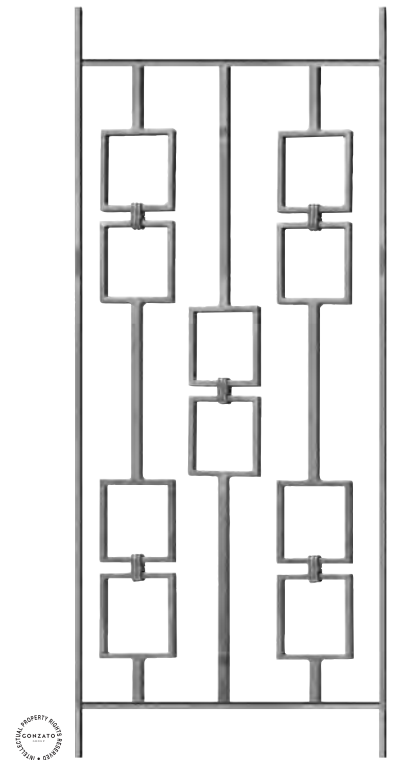

Art. GD183/1
⌀ 14 x 8 mm
400 x 1000 mm

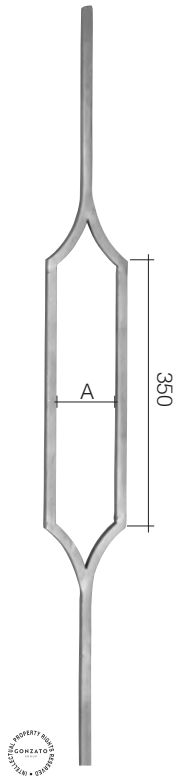

Art. GD25/2
 \varnothing 14 mm
 110 x 1000 mm
 A = 82 mm
 Art. GD243/1
 \varnothing 12 mm
 110 x 1000 mm
 A = 86 mm

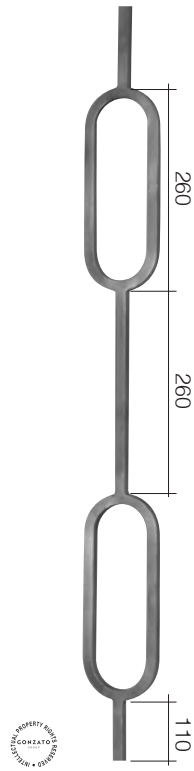

Art. GD29/2
 \varnothing 14 mm
 L 100 mm
 H 1000 mm



Art. GD278/1
 \varnothing 14 x 8 mm
 L 105 mm
 H 1000 mm



Art. GD278/2
 \varnothing 14 x 8 mm
 L 105 mm
 H 1000 mm

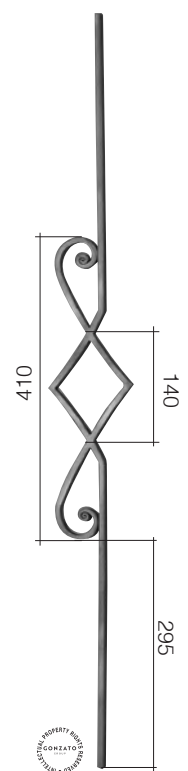

Art. GD19/4
 \varnothing 14 x 8 mm
 L 100 mm
 H 1000 mm



Art. GD305/1
 \varnothing 20 x 6 mm
 112 x 1016 mm



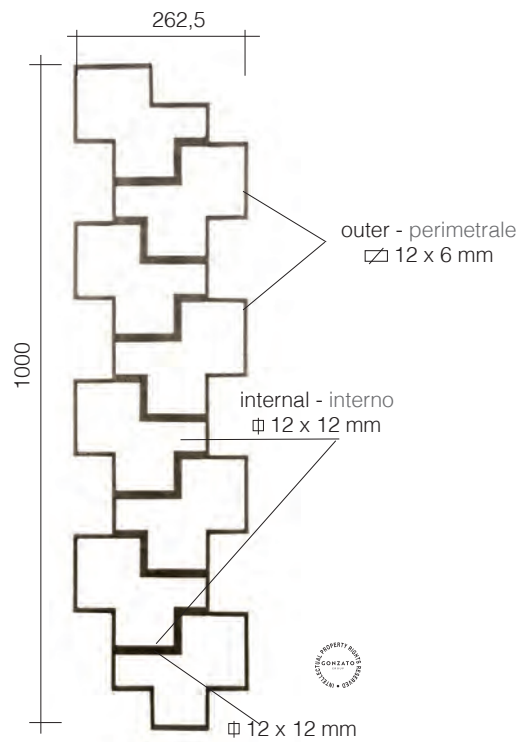

Art. GD293/1
12 x 6 mm + 12 mm
262,5 x 1000 mm



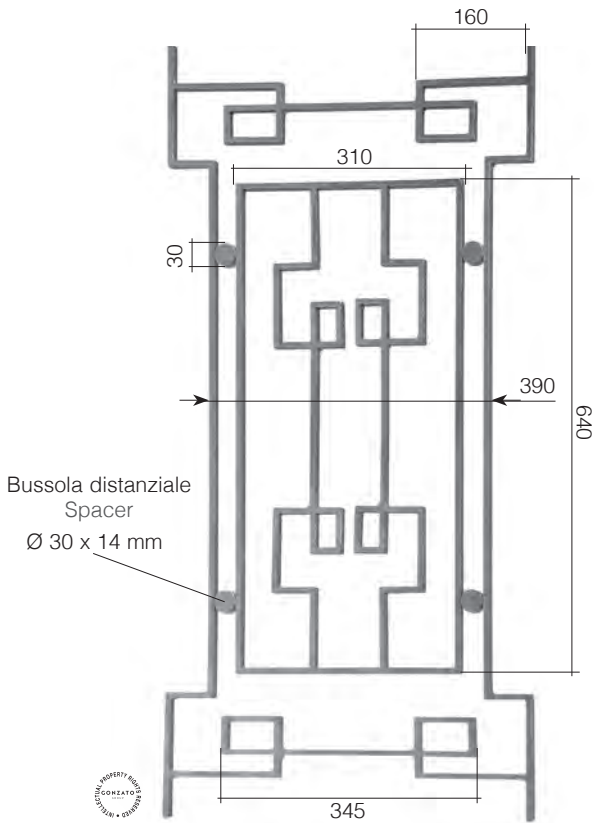

Art. GD202/1
 □ 14 x 8 mm
 L 500 mm
 H 1000 mm

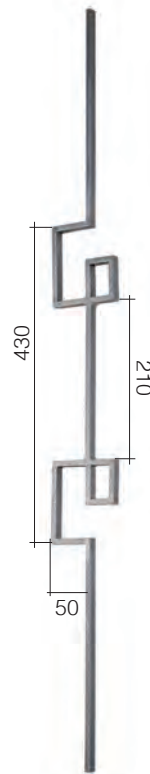

Art. GD202/2
 □ 14 x 8 mm
 L 95 mm
 H 1000 mm

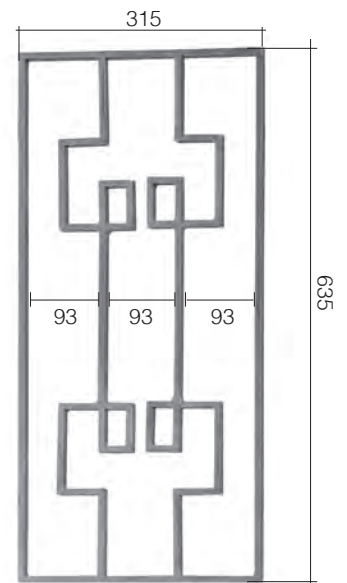

Art. GD202/4
 □ 14 x 8 mm
 L 315 mm
 H 635 mm



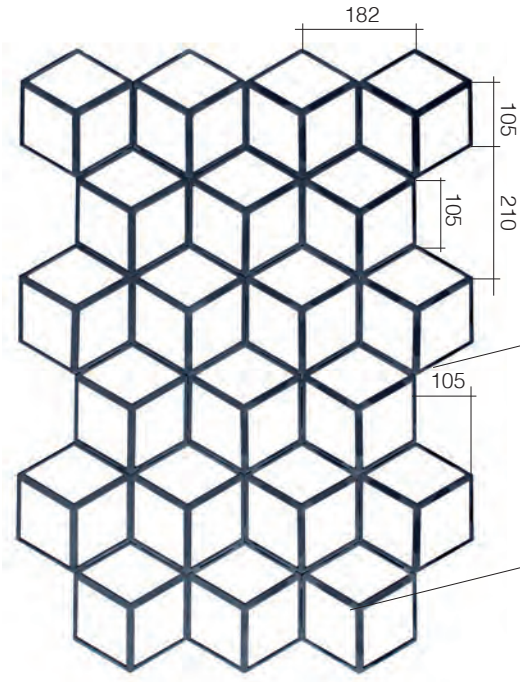

Art. GD287/1
 $\square 12 \times 6 \text{ mm} + \Phi 12 \text{ mm}$
 729 x 1000 mm

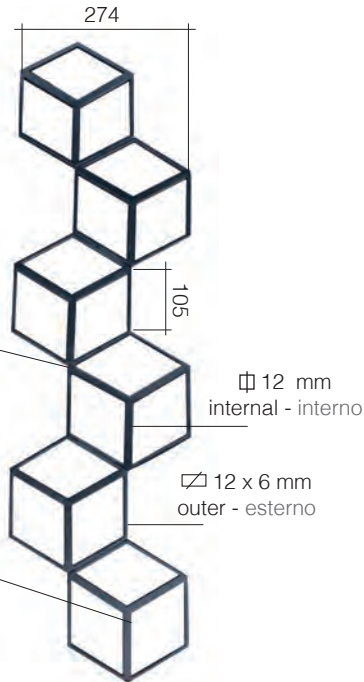

Art. GD287/2
 $\square 12 \times 6 \text{ mm} + \Phi 12 \text{ mm}$
 274 x 1000 mm

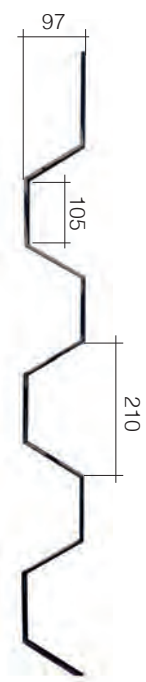

Art. GD287/3
 $\square 12 \times 6 \text{ mm}$
 H 1000 mm



**APPLICATION ON
STAIRCASE
ESEMPIO DI MONTAGGIO
SU SCALA**

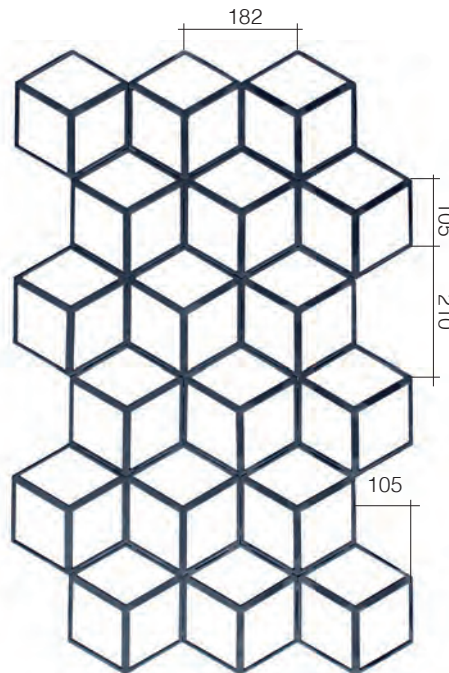

Art. GD287/4
 $\square 12 \times 6 \text{ mm} + \Phi 12 \text{ mm}$
 638 x 1000 mm

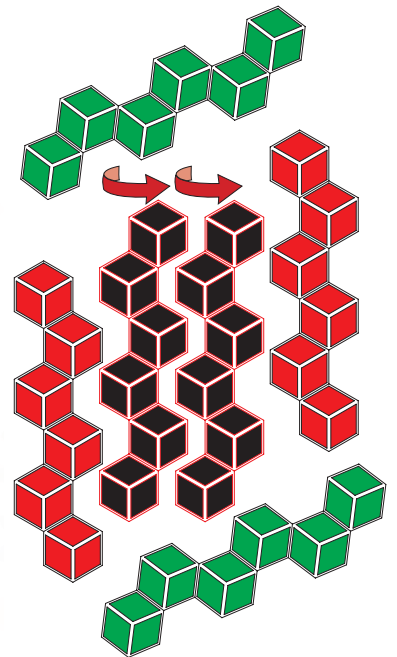

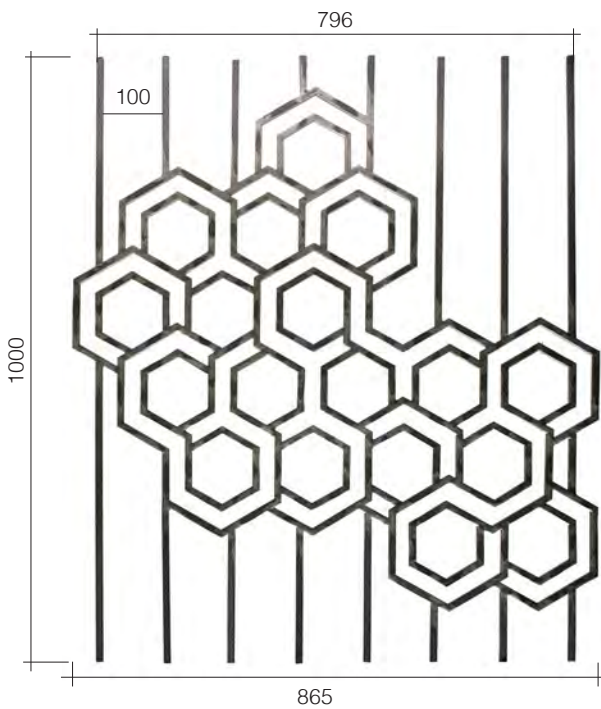

Art. GD301/1
Ø 12 x 12 mm
865 x 1000 mm

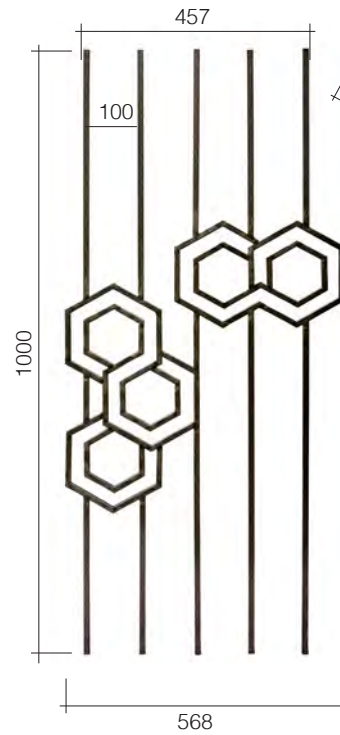

Art. GD301/3
Ø 12 x 12 mm
568 x 1000 mm

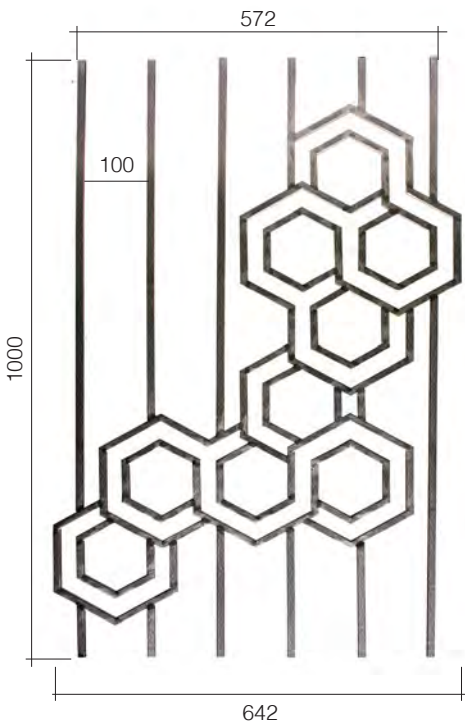
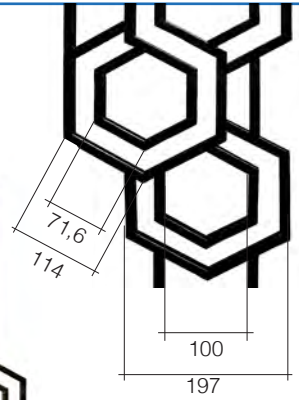

Art. GD301/2
Ø 12 x 12 mm
642 x 1000 mm

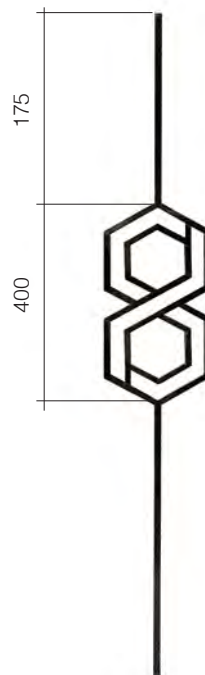

Art. GD301/5
Ø 12 x 12 mm
197 x 1000 mm

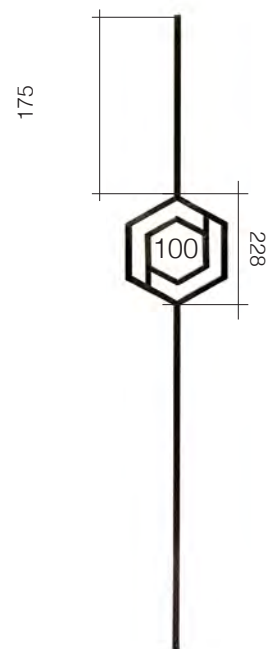

Art. GD301/4
Ø 12 x 12 mm
197 x 1000 mm



OVERLAPPED PANELS - PANNELLI SOVRAPPosti

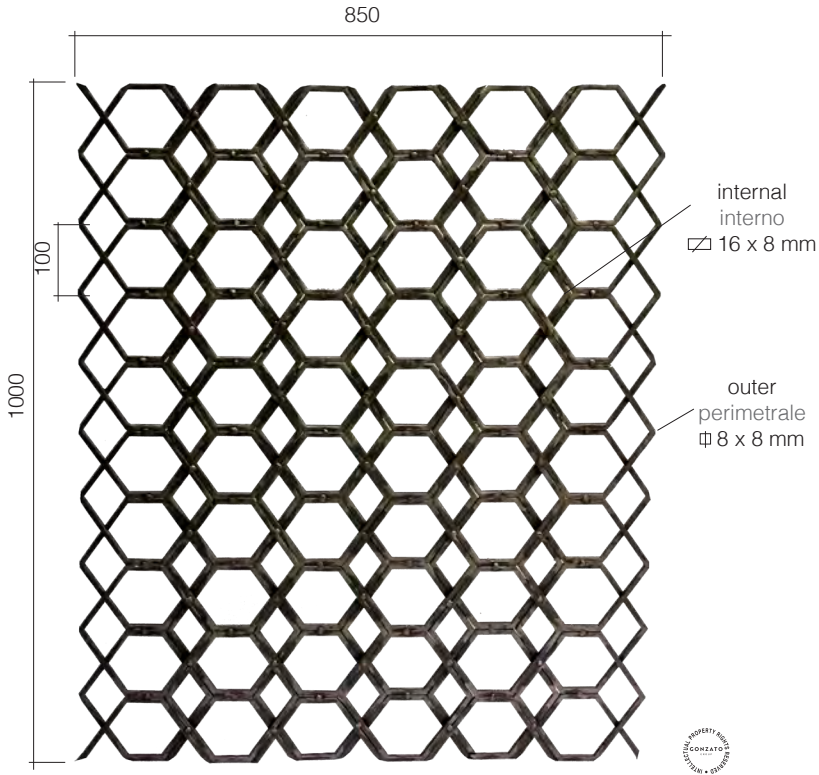

Art. GD299/1
 Φ 8 x 8 mm + \square 16 x 8 mm
 850 x 1000 mm

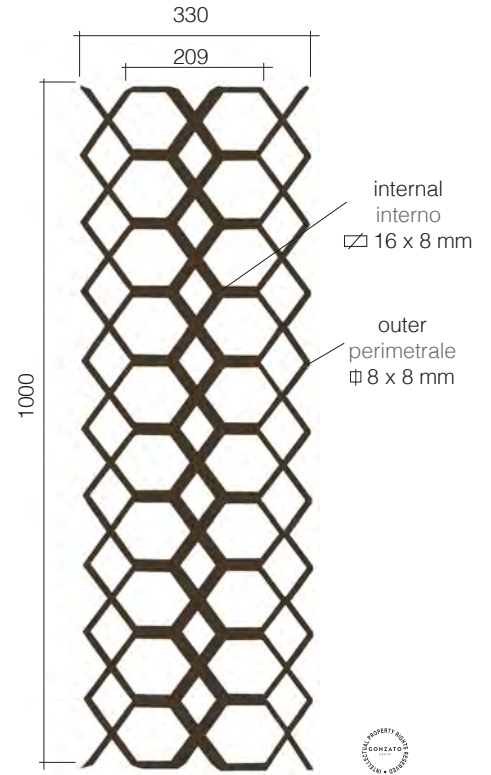

Art. GD299/2
 Φ 8 x 8 mm + \square 16 x 8 mm
 330 x 1000 mm

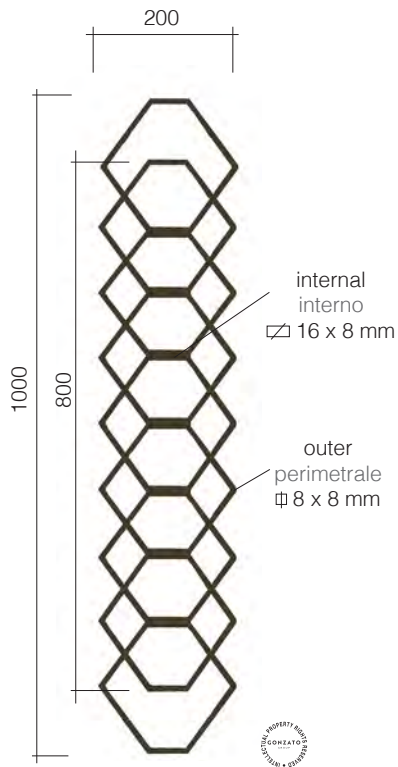

Art. GD299/3
 Φ 8 x 8 mm + \square 16 x 8 mm
 200 x 1000 mm

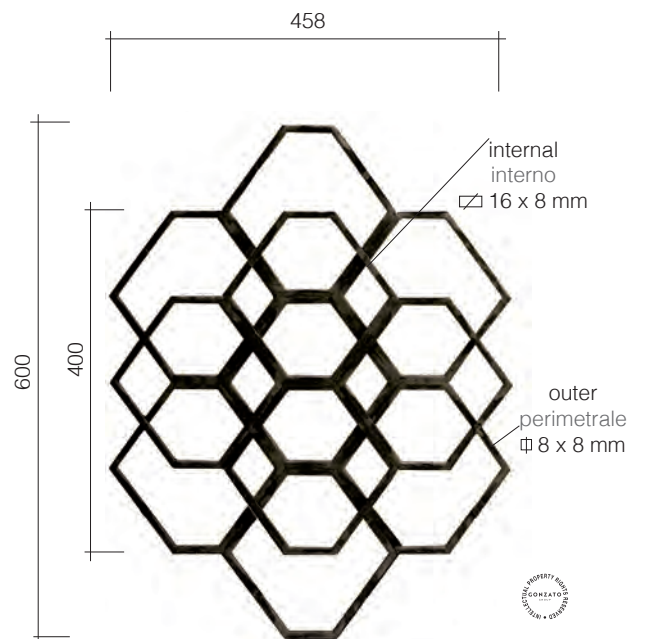

Art. GD299/4
 Φ 8 x 8 mm + \square 16 x 8 mm
 458 x 600 mm



OVERLAPPED PANELS
PANNELLI SOVRAPPOSTI



Panels with sheet metal, 1 mm thick
woven between rods, 8 mm diameter

Pannelli con lamiera spessore 1 mm
intrecciata tra tondini Ø 8 mm

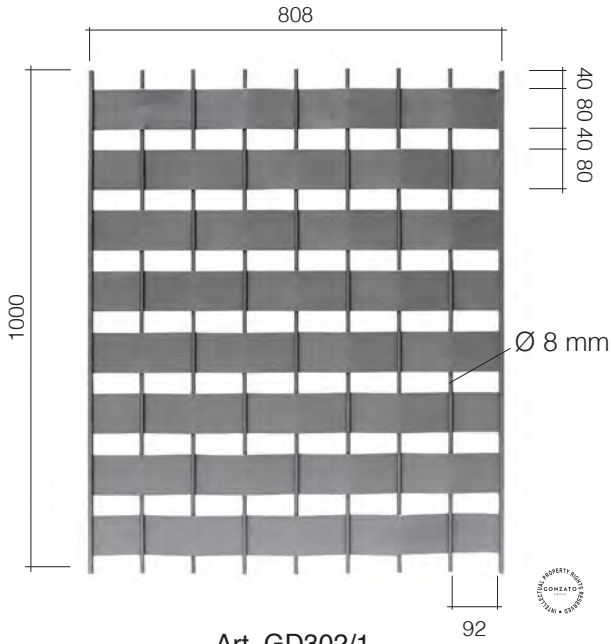

Art. GD302/1
16 x 8 mm
808 x 1000 mm

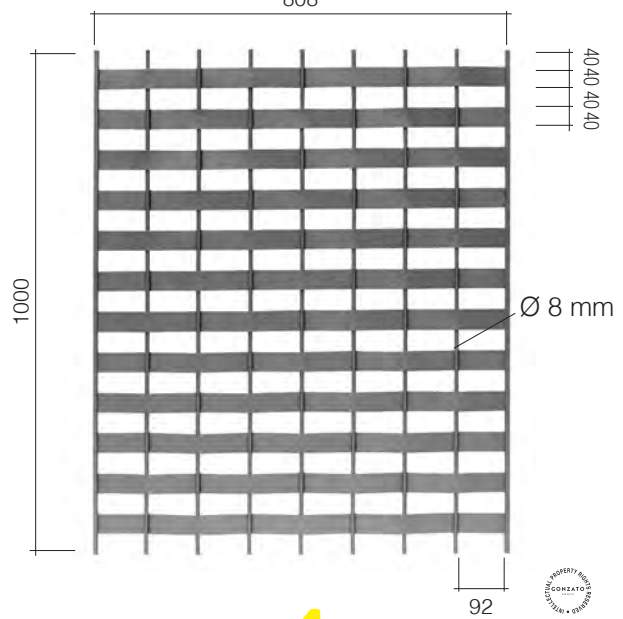

Art. GD302/2
16 x 8 mm
808 x 1000 mm

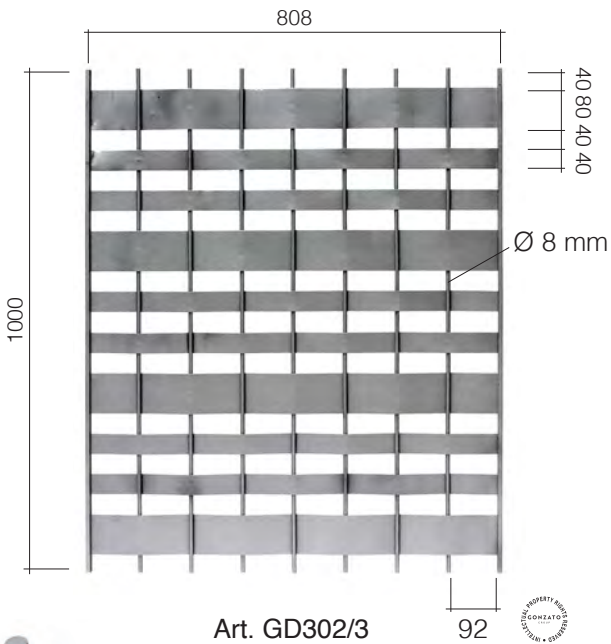

Art. GD302/3
16 x 8 mm
808 x 1000 mm

ATTENZIONE:
Viste le peculiarità del
prodotto, questo articolo è
solo **zincabile a freddo**.
Una zincatura a caldo
potrebbe comprometterne
l'estetica

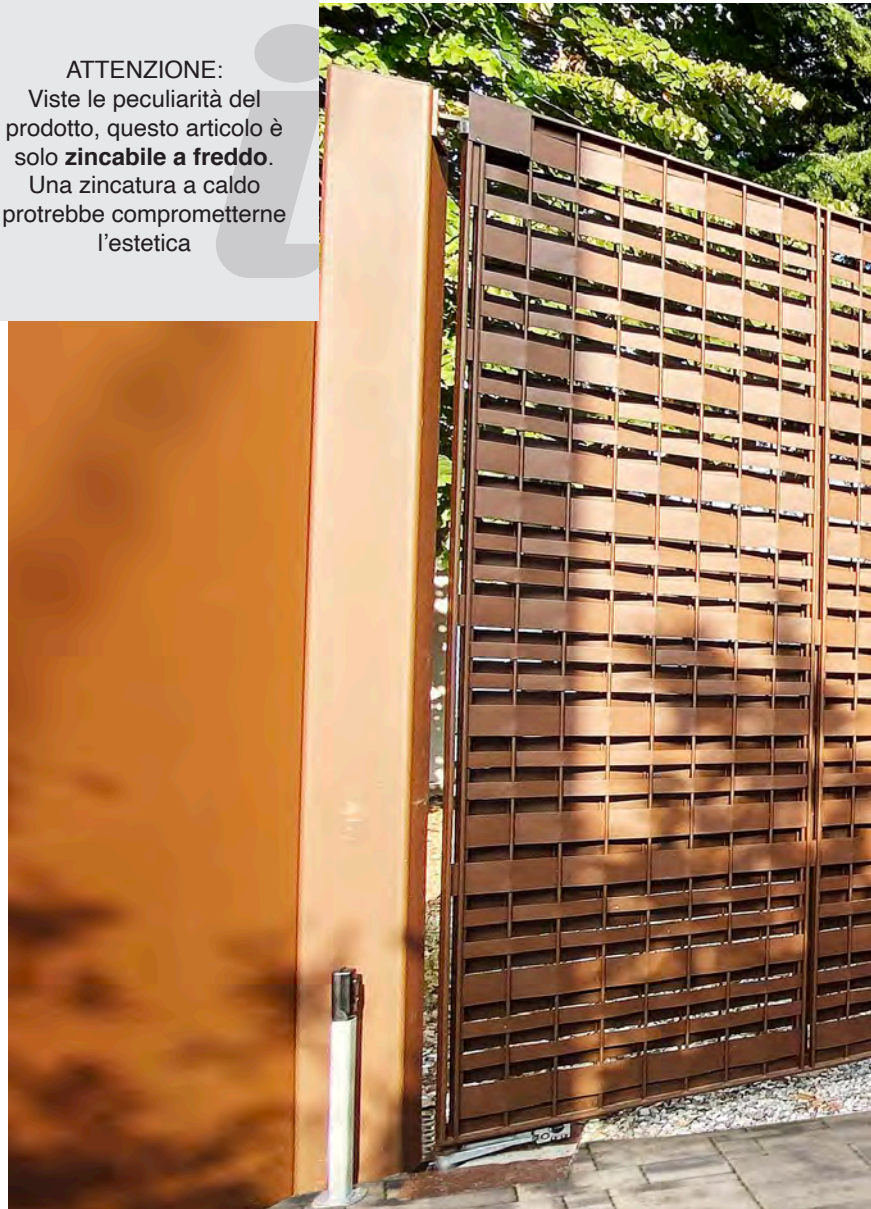
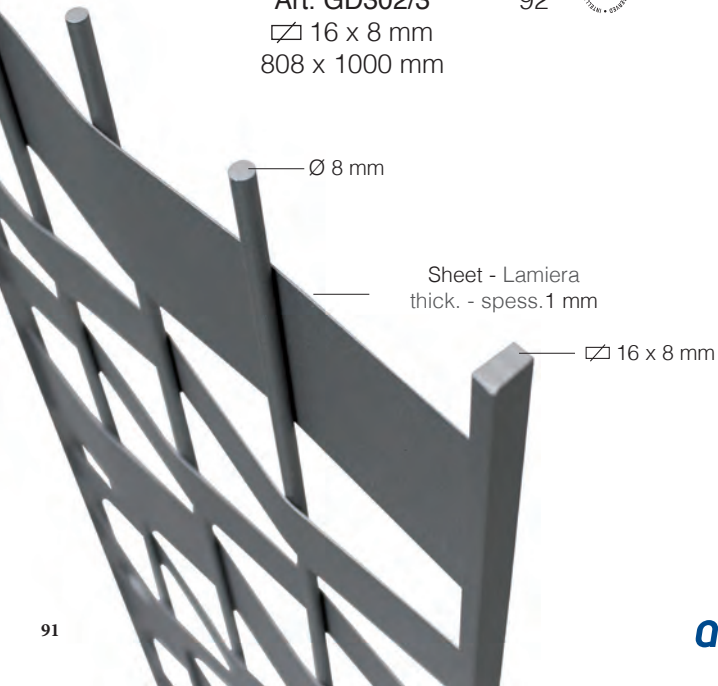

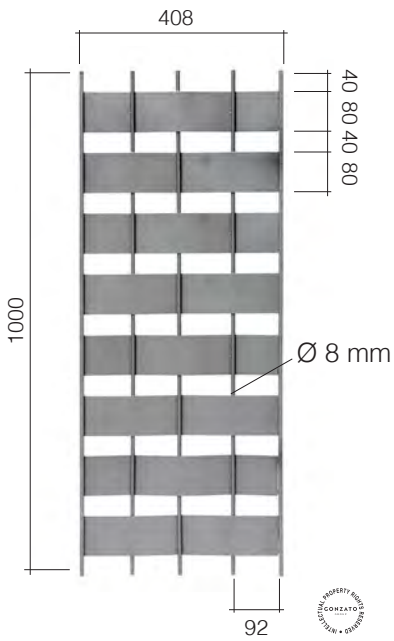

Art. GD303/1
 \square 16 x 8 mm
 408 x 1000 mm

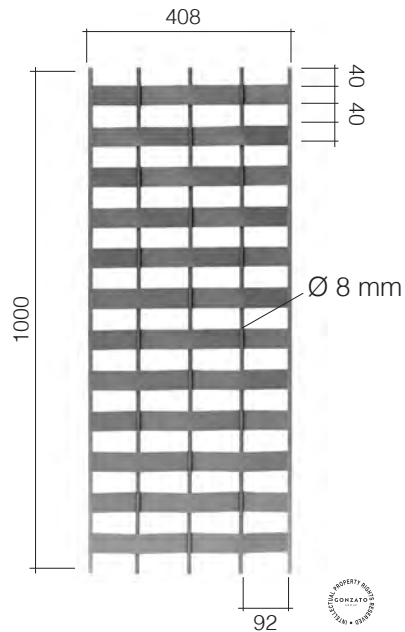

Art. GD303/2
 \square 16 x 8 mm
 408 x 1000 mm

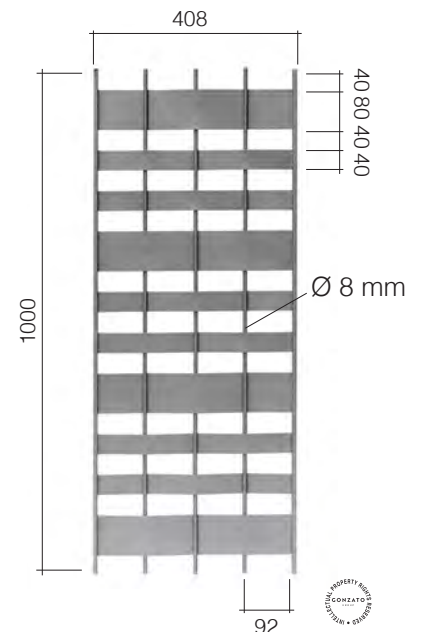

Art. GD303/3
 \square 16 x 8 mm
 408 x 1000 mm

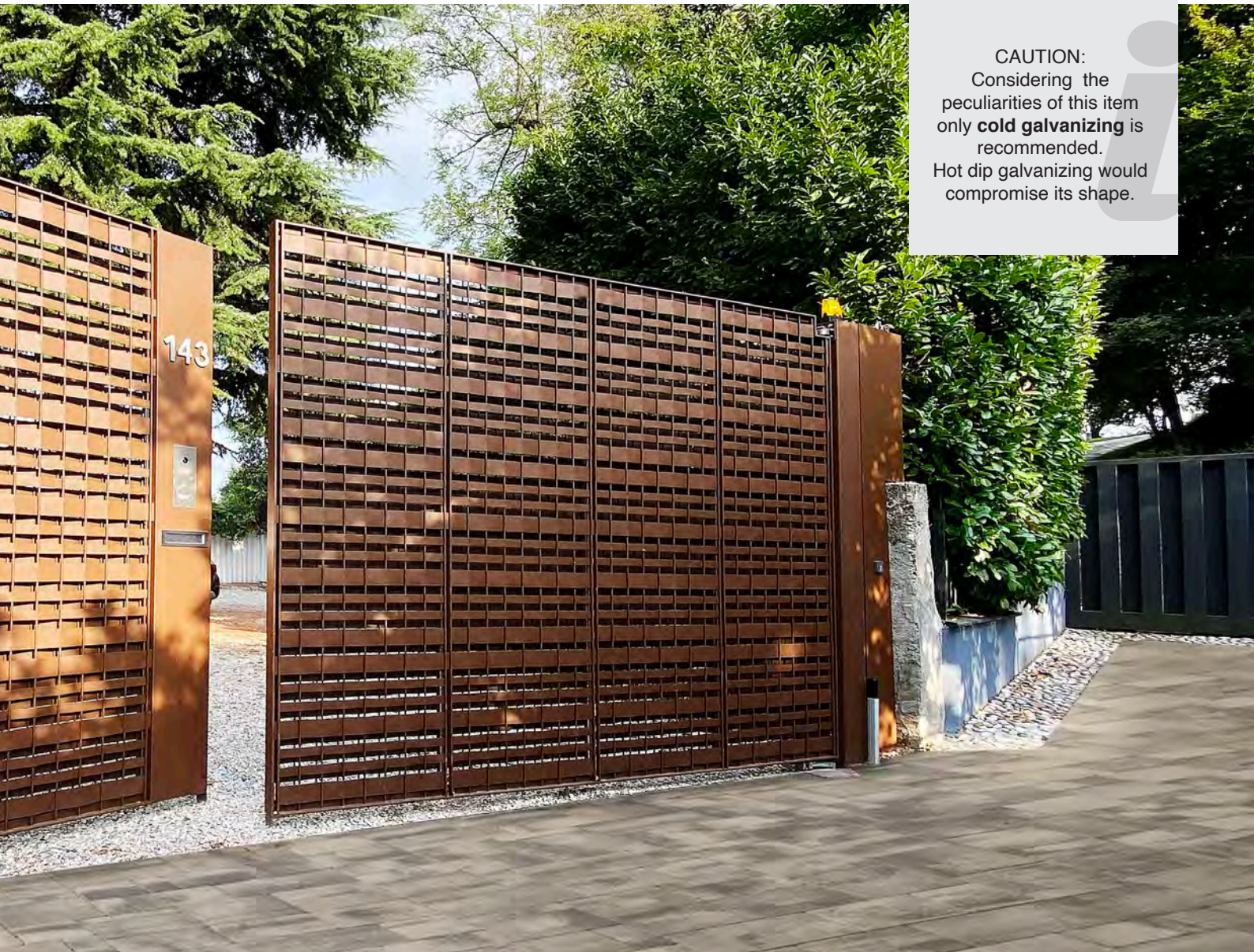

CAUTION:
 Considering the peculiarities of this item only **cold galvanizing** is recommended. Hot dip galvanizing would compromise its shape.

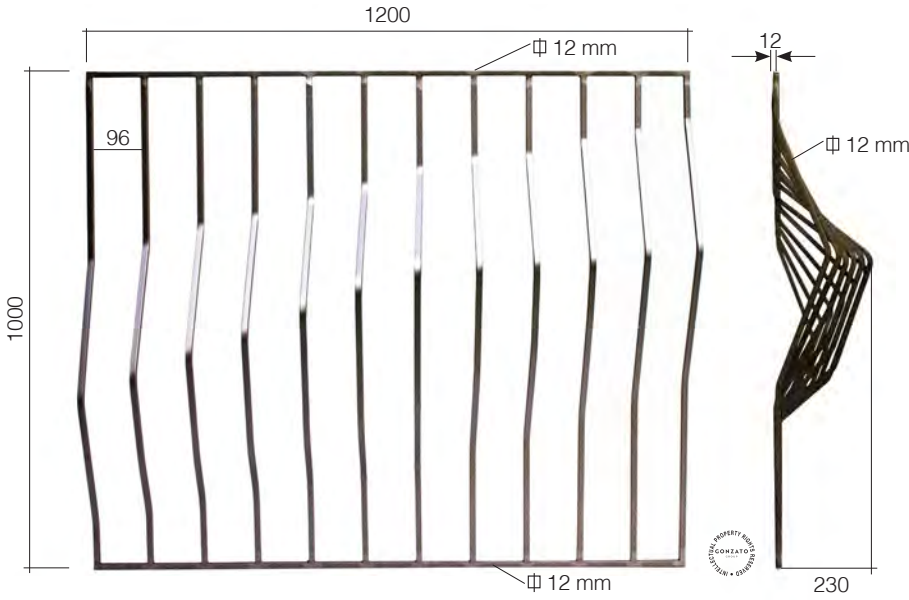

left - sinistro
Art. GD289/2
Φ 12 x 12 mm
1200 x 1000 mm

right - destro
Art. GD289/2/S
Φ 12 x 12 mm
1200 x 1000 mm

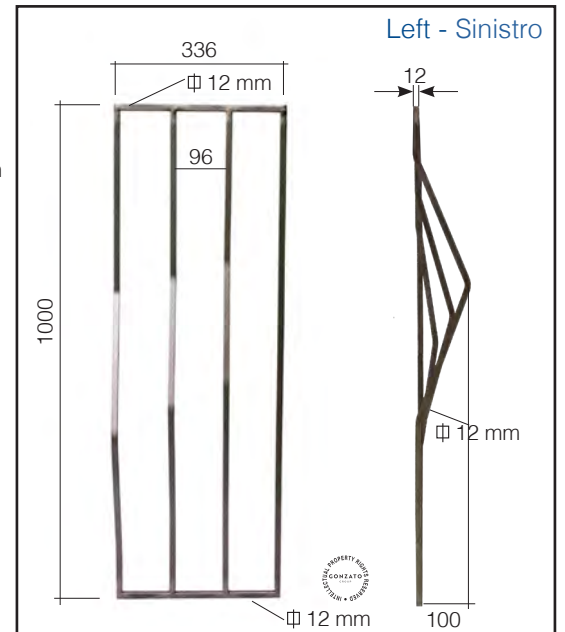

left - sinistro
Art. GD293/3
Φ 12 x 12 mm
336 x 1000 mm

right - destro
Art. GD293/3/S
Φ 12 x 12 mm
336 x 1000 mm

Elements to lead the
buffing waves at level
zero

Elementi per portare
l'onda di tamponatura
a livello zero

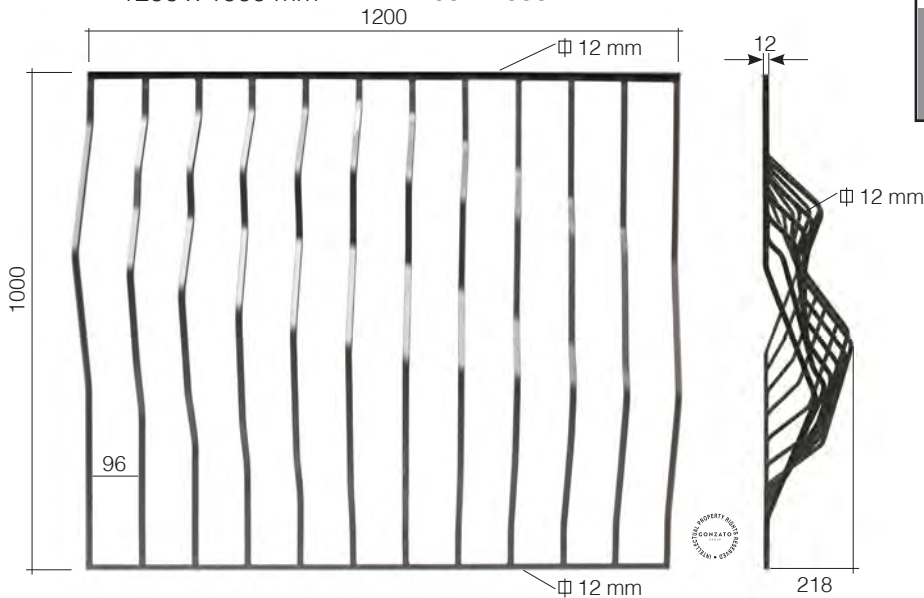

left - sinistro
Art. GD289/1
Φ 12 x 12 mm
1200 x 1000 mm

right - destro
Art. GD289/1/S
Φ 12 x 12 mm
1200 x 1000 mm



vertical elements Ø 12 mm
horizontal elements \square 12 mm

elementi verticali Ø 12 mm
elementi orizzontali \square 12 mm
1200

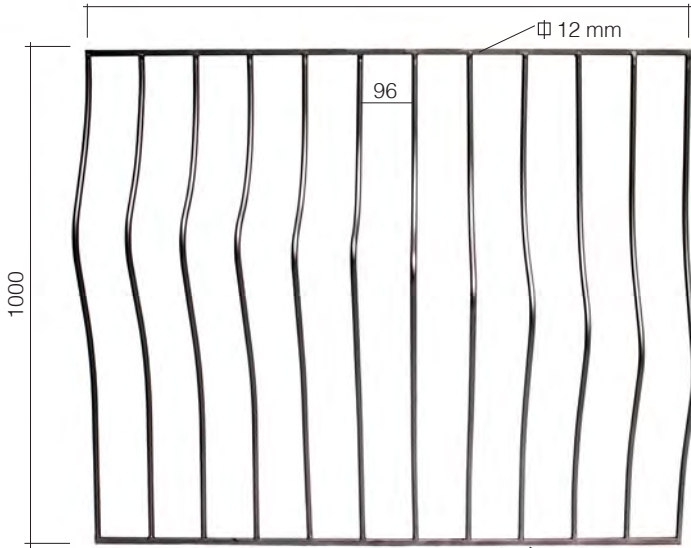

left - sinistro Art. GD294/1
right - destro Art. GD294/1/S
Ø 12 mm Ø 12 mm
1200 x 1000 mm 1200 x 1000 mm

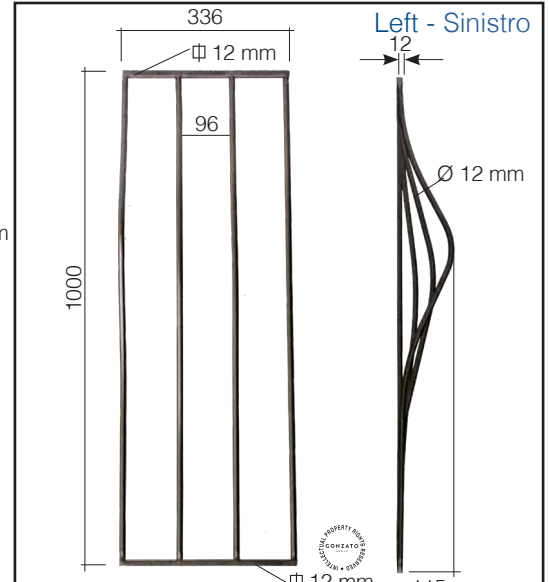

left - sinistro Art. GD294/3
right - destro Art. GD294/3/S
Ø 12 mm Ø 12 mm
336 x 1000 mm 336 x 1000 mm

Elements to lead the buffing waves at level zero

Elementi per portare l'onda di tamponatura a livello zero

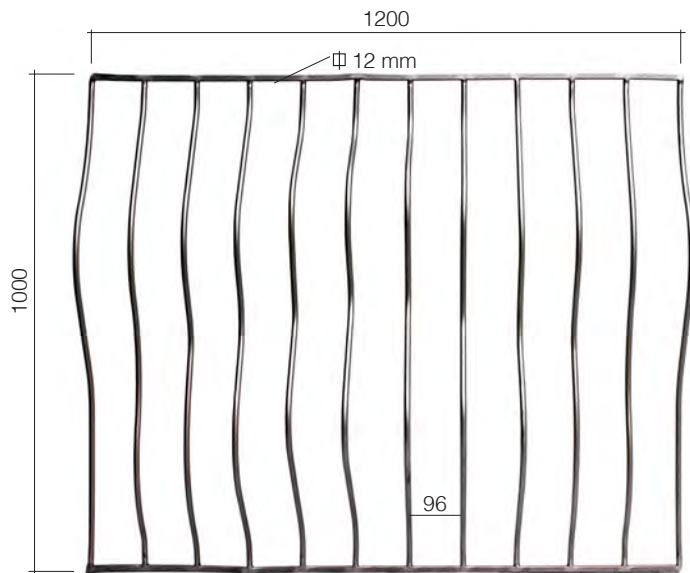

left - sinistro Art. GD294/2
right - destro Art. GD294/2/S
Ø 12 mm Ø 12 mm
1200 x 1000 mm 1200 x 1000 mm

vertical elements Ø 12 mm
horizontal elements \square 12 mm
elementi verticali Ø 12 mm
elementi orizzontali \square 12 mm

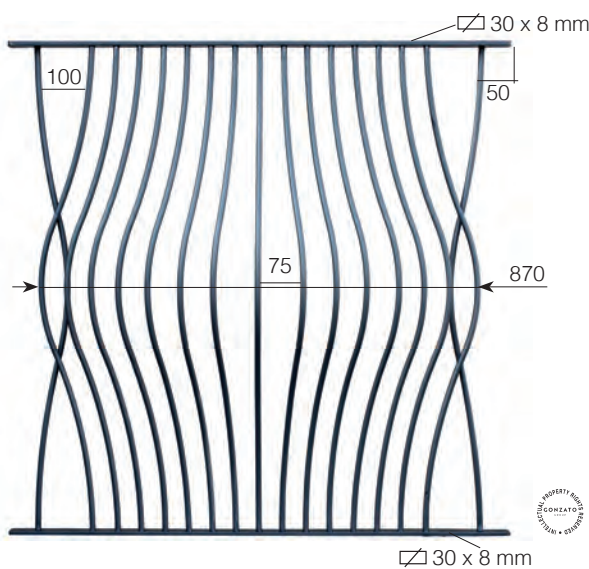

vertical elements Ø 12 mm
horizontal elements \square 30 x 8 mm
elementi verticali Ø 12 mm
elementi orizzontali \square 30 x 8 mm

Art. GD288/1
Ø 12 mm
1000 x 1000 mm

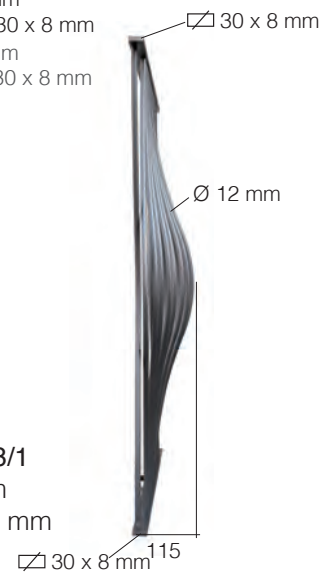



Left - Sinistro

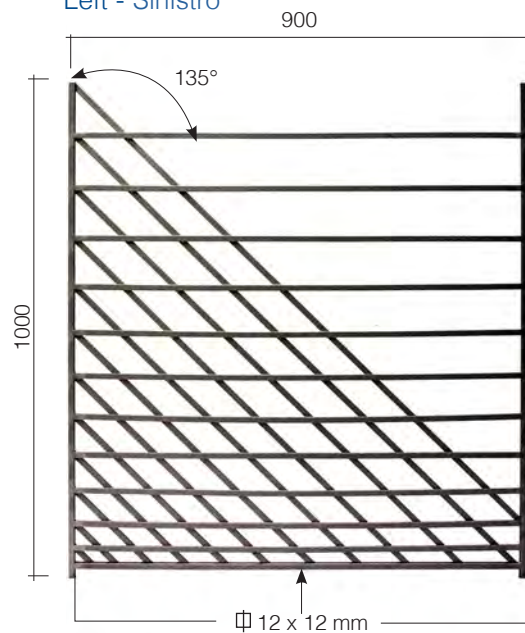

left - sinistro

Art. GD297/1

□ 12 x 6 mm + ∅ 12 mm

L 900 mm

H 1000 mm

right - destro

Art. GD297/2

□ 12 x 6 mm + ∅ 12 mm

L 900 mm

H 1000 mm

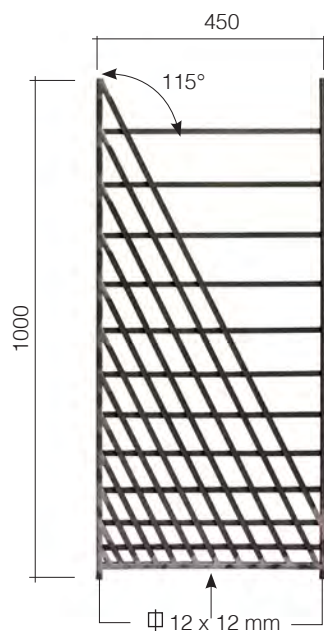

left - sinistro

Art. GD298/1

□ 12 x 6 mm + ∅ 12 mm

L 450 mm

H 1000 mm

right - destro

Art. GD298/2

□ 12 x 6 mm + ∅ 12 mm

L 450 mm

H 1000 mm



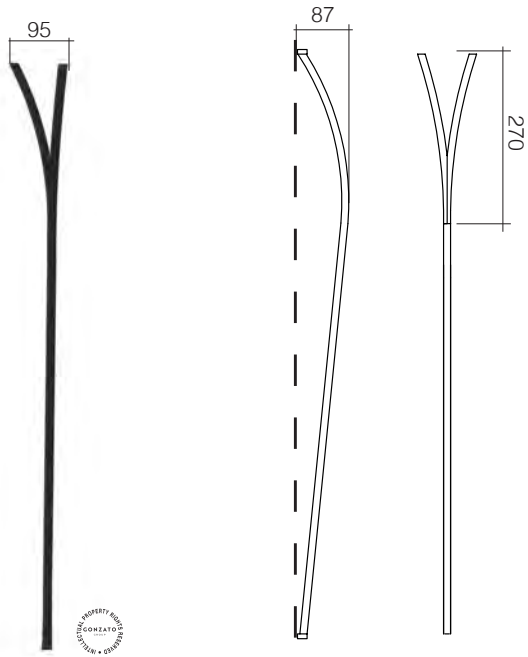

Art. GD290/2
∅ 12 mm
H 1000 mm

BEST PRICE

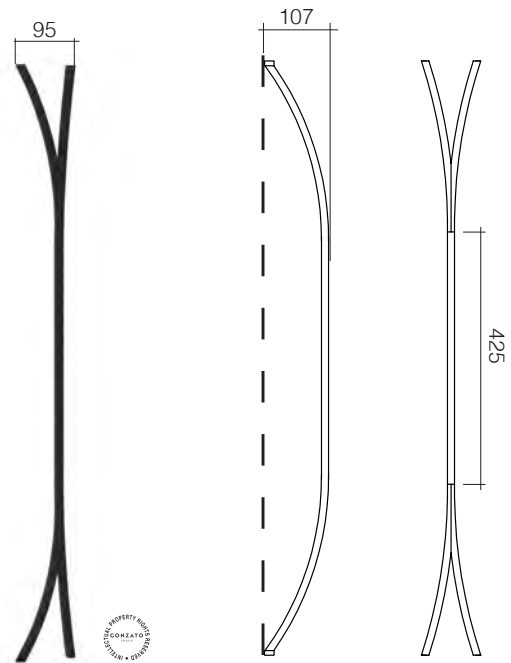

Art. GD290/1
∅ 12 mm
H 1000 mm



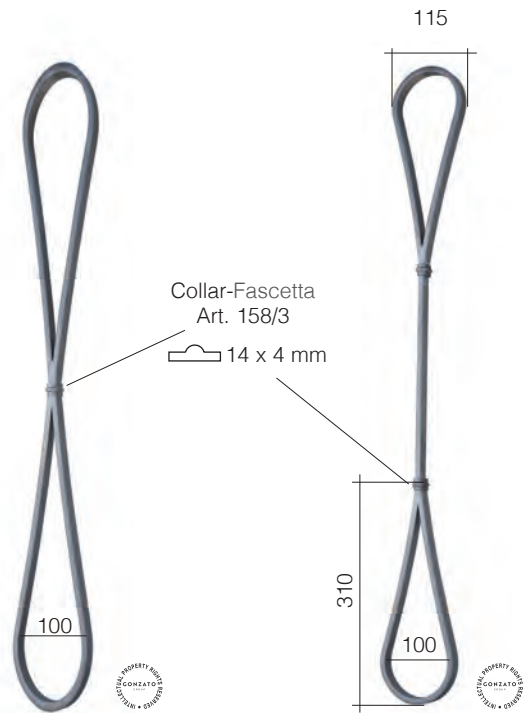

Art. GD179/2
□ 14 x 8 mm
115 x 1000 mm

Art. GD179/1
□ 14 x 8 mm
115 x 1000 mm

Horizontal flat bar
Piatti orizzontali
□ 25 x 6 mm

Sphere-Sfere
Art. 116/F/3
Ø 30 mm

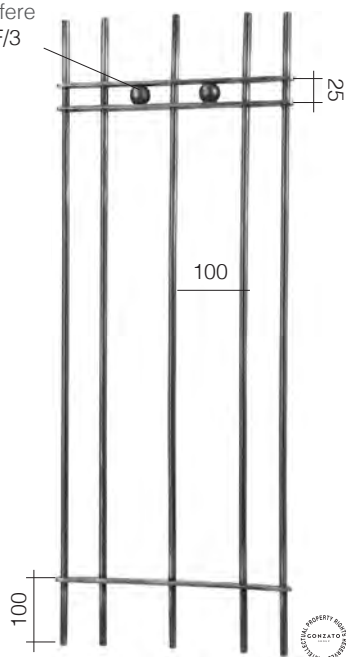

Art. GD47/3
Ø 12 mm
360 x 1000 mm

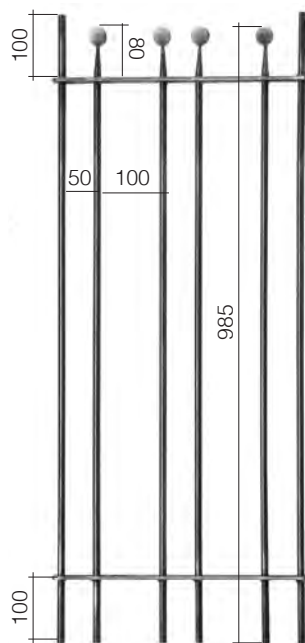

Art. GD47/1
Ø 12 mm
L 420 mm
H 1000 mm

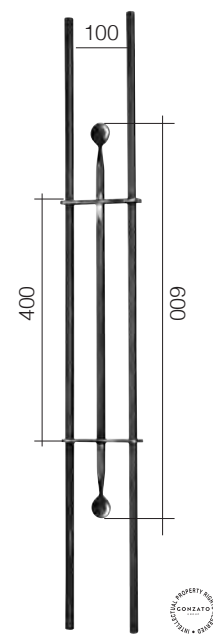

Art. GD67/1
□ 12 mm
L 125 mm
H 1000 mm

Spheres - Sfere Ø 30 mm

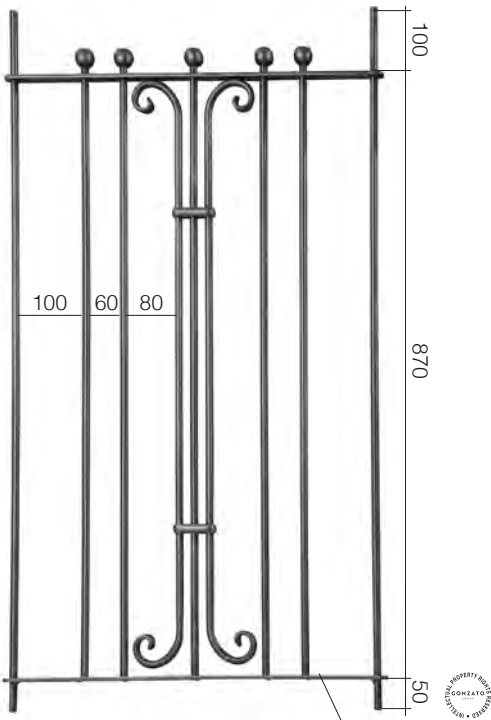

Art. GD45/1
Ø 12 mm
610 x 1000 mm
25 x 6 mm

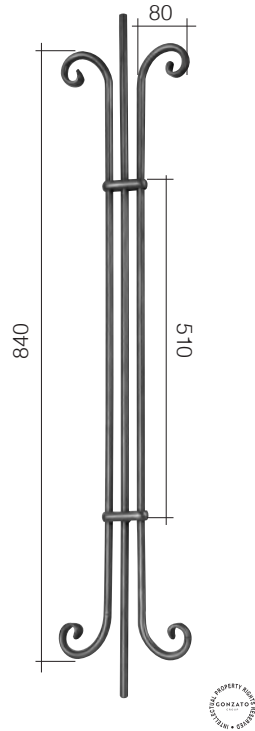

Art. GD45/2
Ø 12 mm
200 x 1000 mm

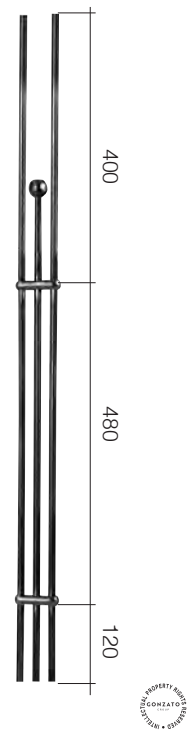

Art. GD39/2
Ø 12 mm
60 x 1000 mm

Spheres - Sfere Ø 30 mm

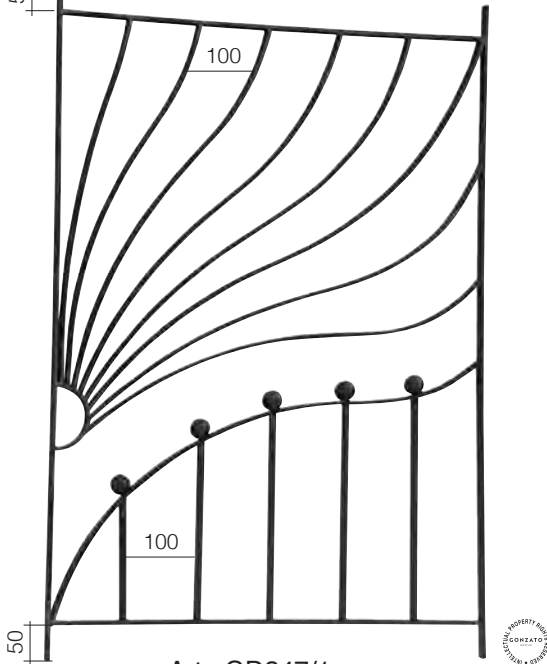

Art. GD247/1
20 x 6 mm
670 x 1000 mm



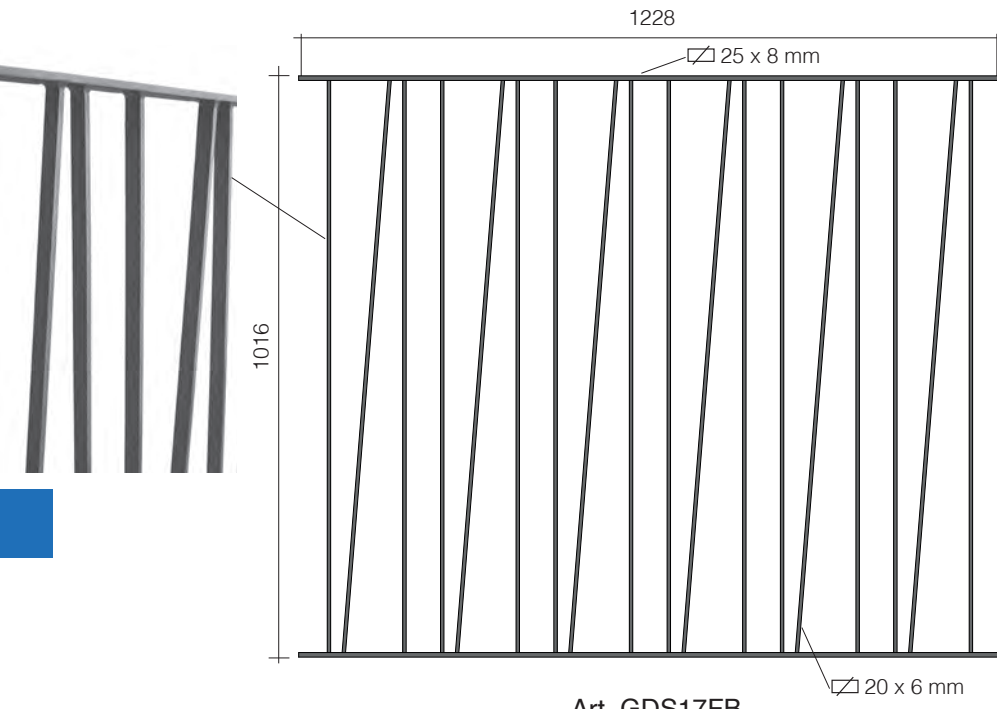

Art. GDS17FB
20 x 6 mm
1228 x 1016 mm

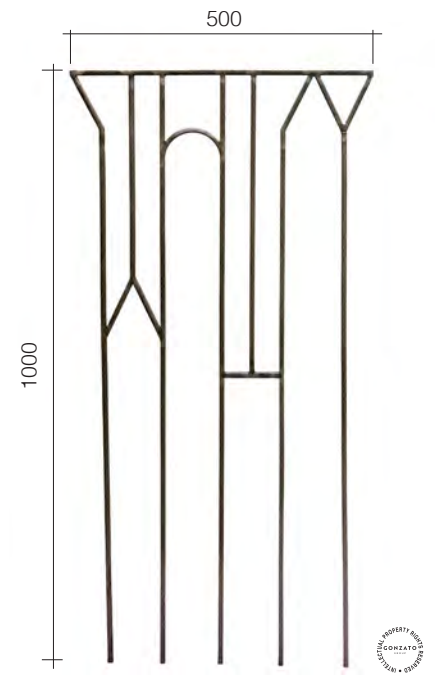

Art. GD295/1
14 x 8 mm
500 x 1000 mm

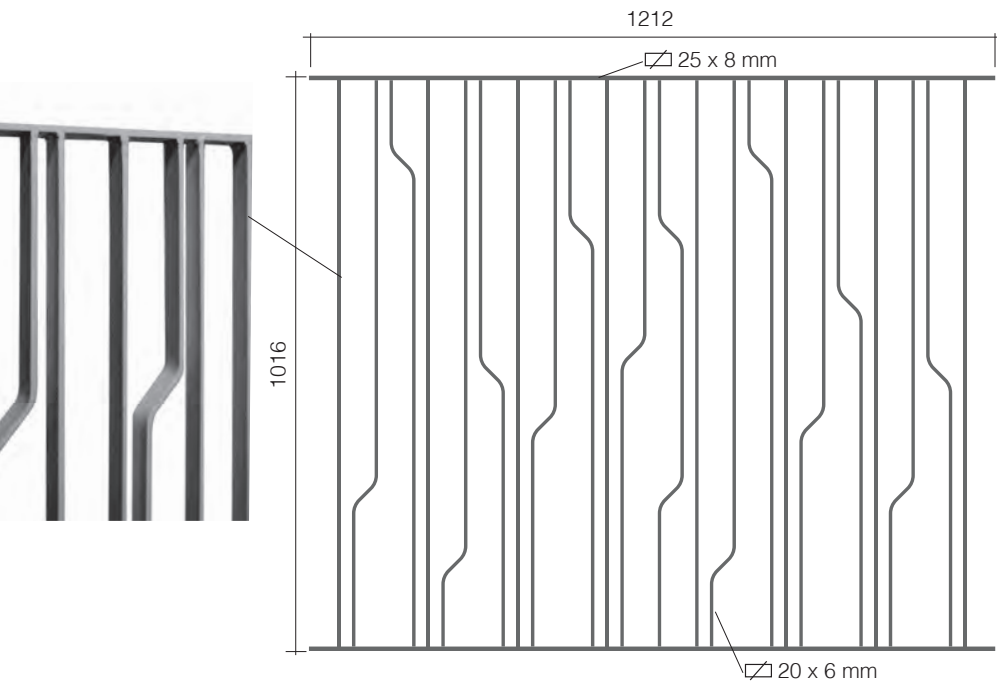

Art. GDS20FB
20 x 6 mm
1212 x 1016 mm

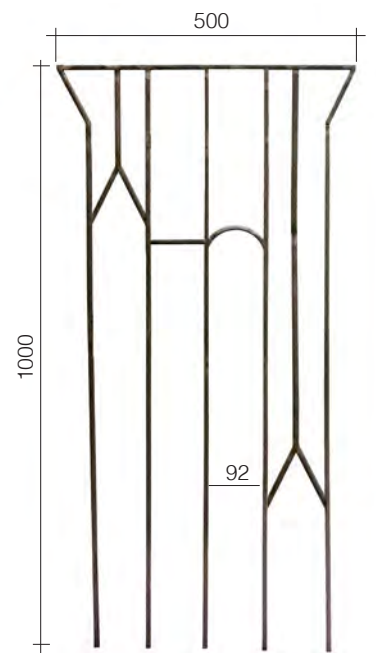

Art. GD295/2
14 x 8 mm
500 x 1000 mm

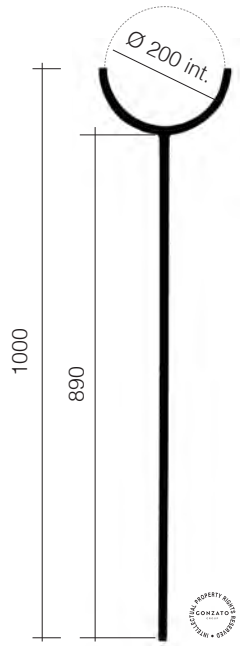

Art. GD296/1
Ø 12 x 12 mm
Ø 224 x 1000 mm

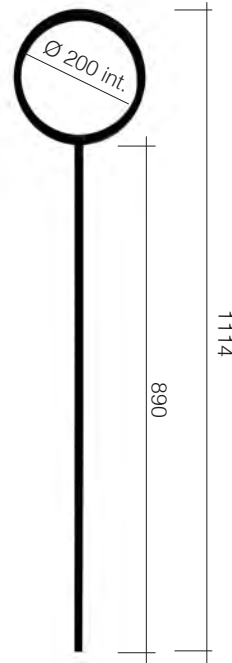

Art. GD296/2
Ø 12 x 12 mm
Ø 224 x 1114 mm



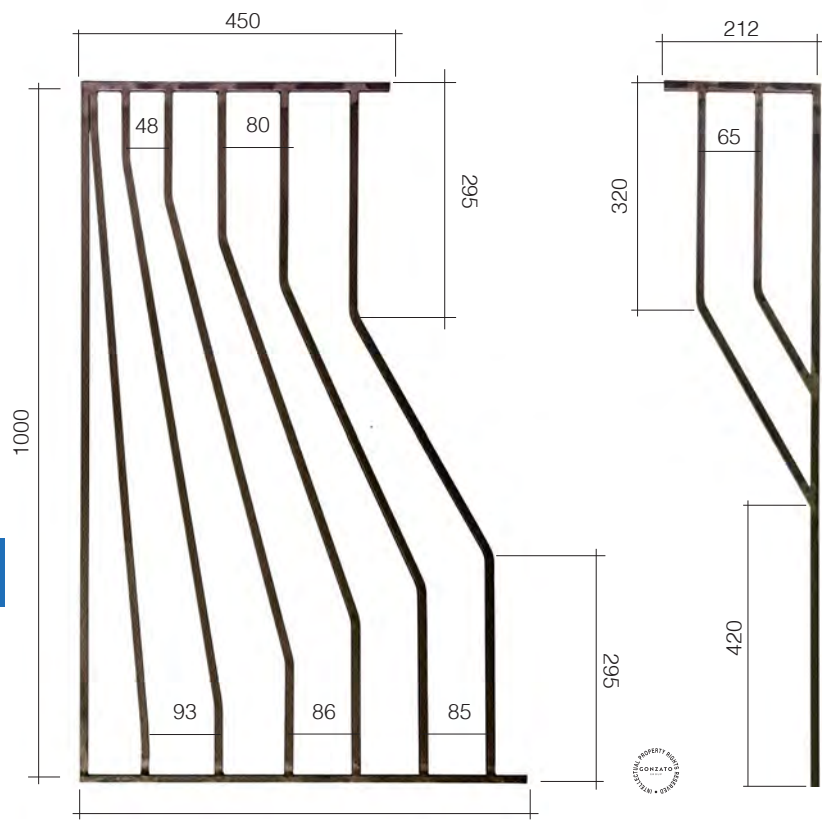

Art. GD212/2
 Φ 12 x 12 mm
 650 x 1000 mm

Art. GD212/3
 Φ 12 x 12 mm
 212 x 1000 mm

ESEMPIO DI MONTAGGIO
 MOUNTING EXAMPLE

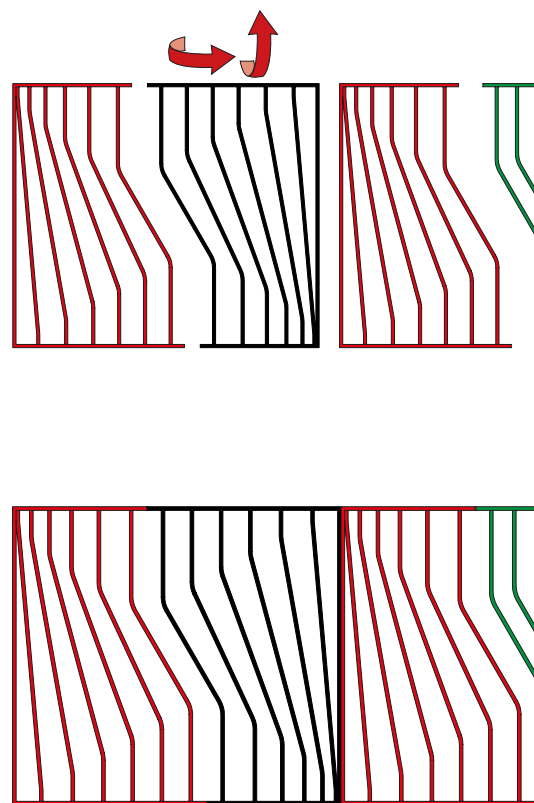



Art. GD222/1
□ 14 x 8 mm
H 1000 mm
L 500 mm



Art. GD222/2
□ 14 x 8 mm
H 1000 mm
L 500 mm

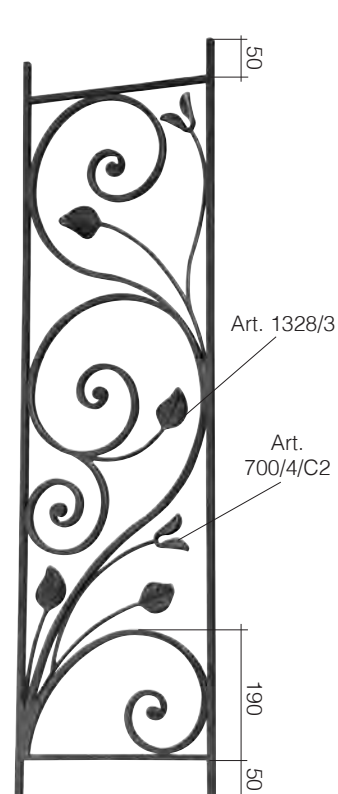

Art. GD223/1
□ 14 x 8 mm
H 1000 mm
L 275 mm

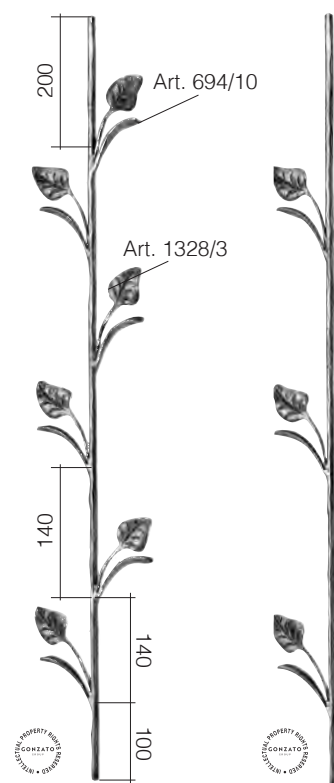

Art. 1170/1
Ø 12 mm
130 x 1000 mm

Art. 1170/5
Ø 12 mm
70 x 1000 mm



Art. 1170/2
Ø 12 mm
130 x 1000 mm



Art. 1171/1
Ø 12 mm
120 x 1000 mm

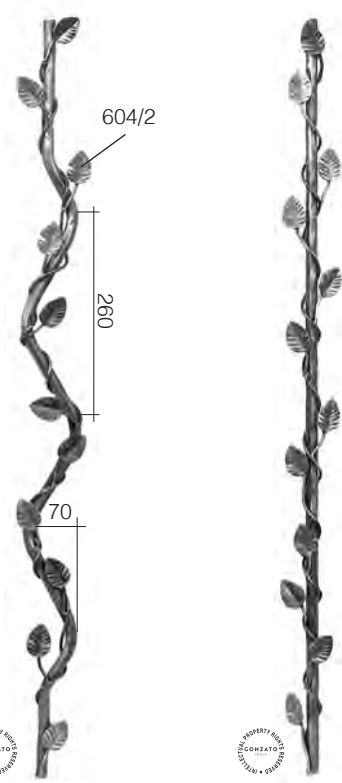

Art. 604/6
Ø 12 mm
H 1000 mm

Art. 604/7
Ø 12 mm
H 1000 mm
Art. 604/2
Ø 16 mm
H 1000 mm

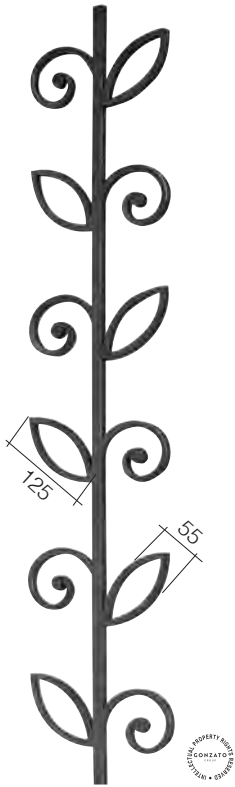

Art. GD176/3
Ø 14 x 14 mm
200 x 1000 mm

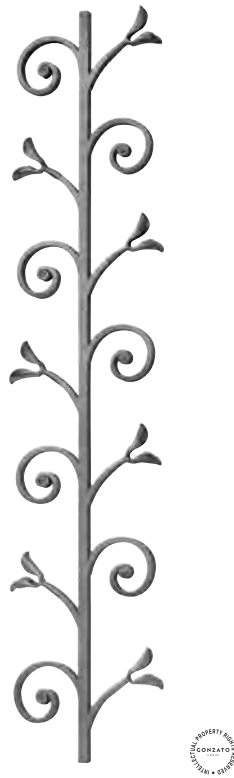

Art. GD176/2
Ø 14 x 14 mm
200 x 1000 mm



Art. GD176/1
Ø 14 x 14 mm
200 x 1000 mm

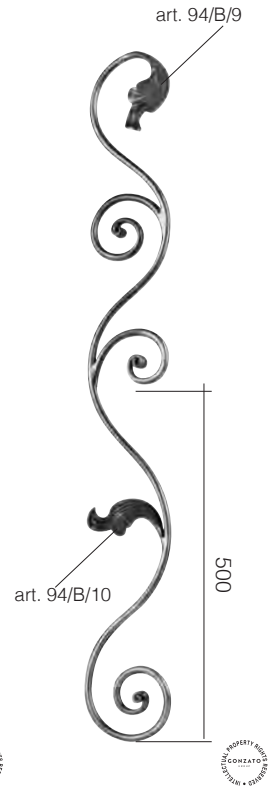

Art. GD170/1
Ø 12 mm
130 x 1000 mm

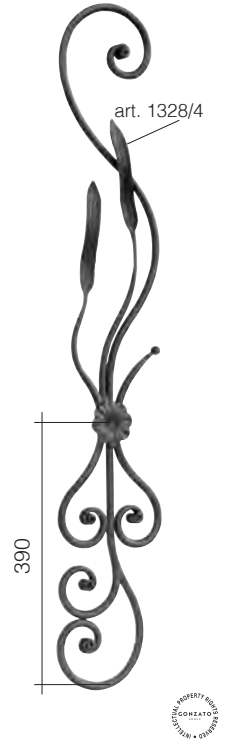

Art. GD170/2
Ø 12 mm
170 x 1000 mm



Ornamenti / Ornaments \square 14 x 8 mm

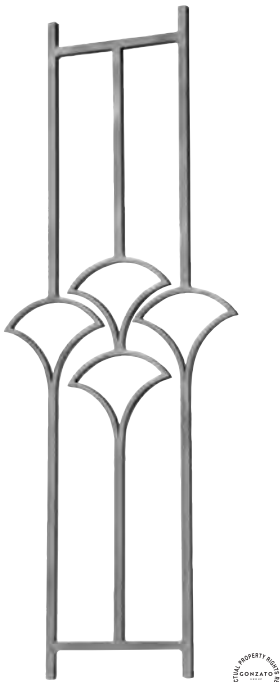

Art. GD186/2
 \square 14 mm
390 x 1000 mm

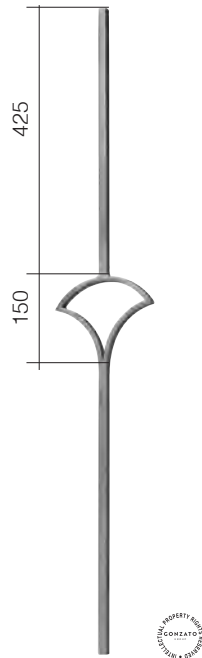

Art. GD186/1
 \square 14 mm
170 x 1000 mm

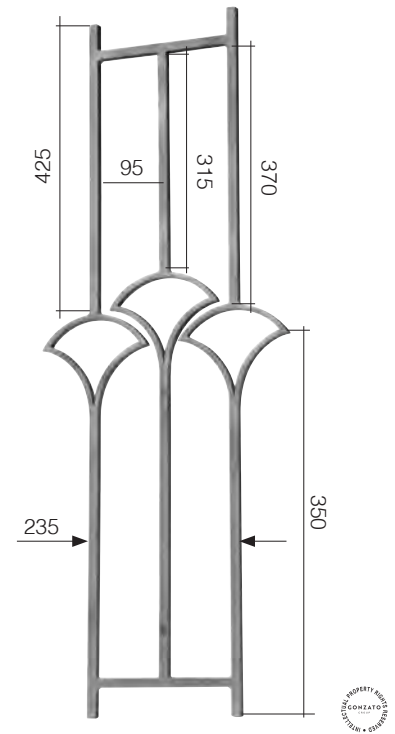

Art. GD186/3
 \square 14 mm
390 x 1000 mm

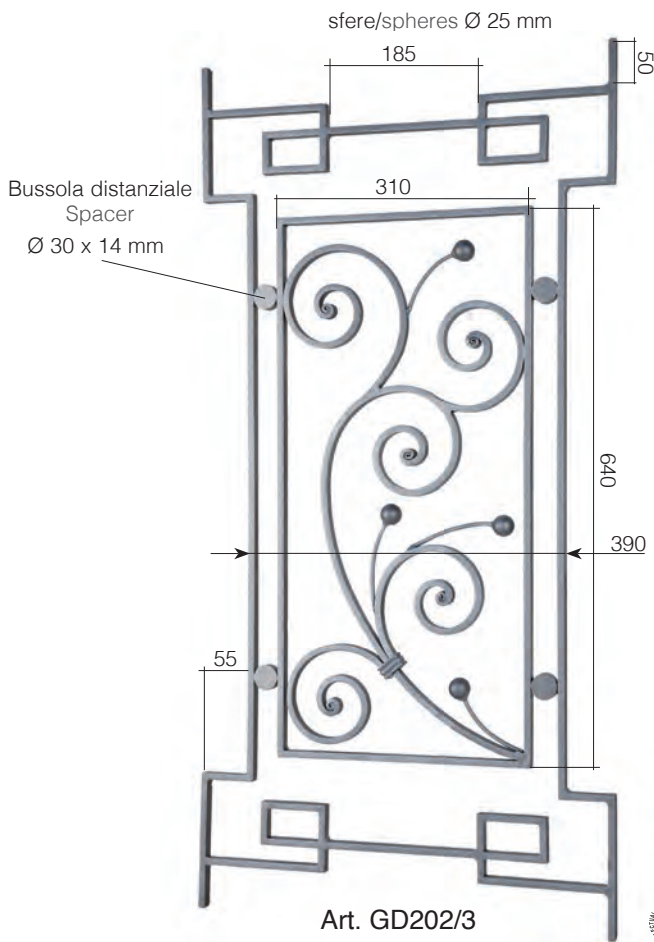

Art. GD202/3
 \square 14 x 8 mm
500 x 1000 mm



Art. GD202/5
 \square 14 x 8 mm
315 x 635 mm

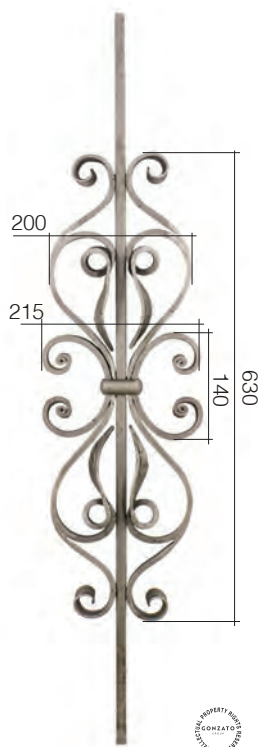

Art. GD28/1
Ø 14 mm
215 x 1000 mm

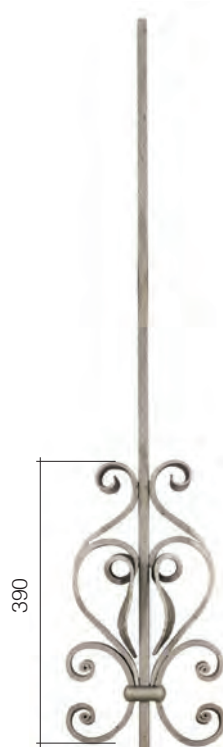

Art. GD28/2
Ø 14 mm
215 x 1000 mm



Art. GD28/3
Ø 14 mm
215 x 1000 mm

Piatti orizzontali
Horizontal flat bar
▧ 25 x 6 mm

Sfera - Sphere
Art. 116/F/4 Ø 40 mm

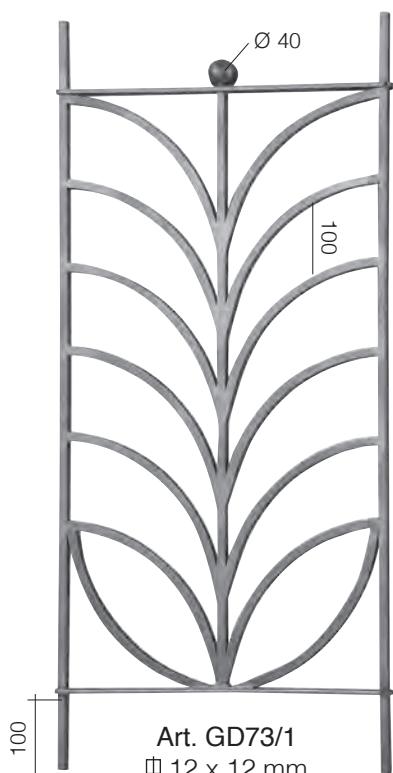

Art. GD73/1
Ø 12 x 12 mm
455 x 1000 mm

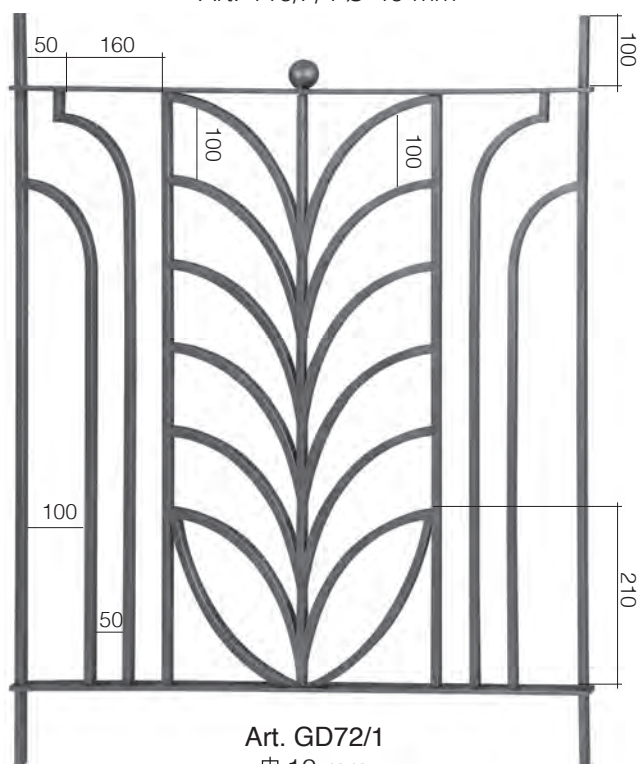

Art. GD72/1
Ø 12 mm
935 x 1000 mm

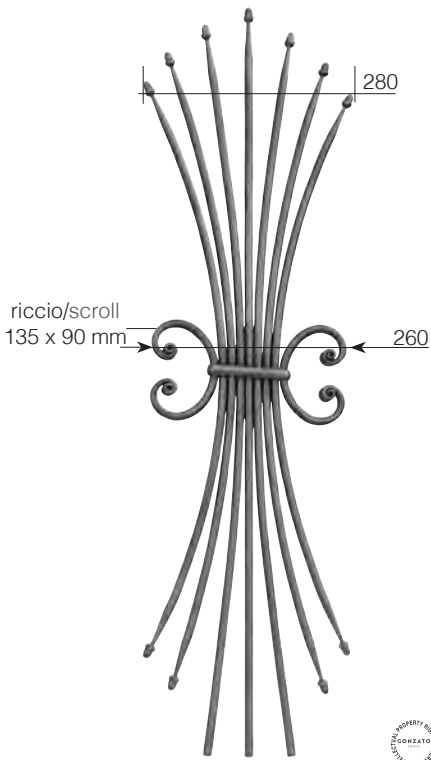

Art. GD255/1
Ø 12 mm
280 x 1000 mm



Art. 1171/2
Ø 12 mm
60 x 1000 mm



Art. GD92/3
Ø 12 mm
100 x 1000 mm

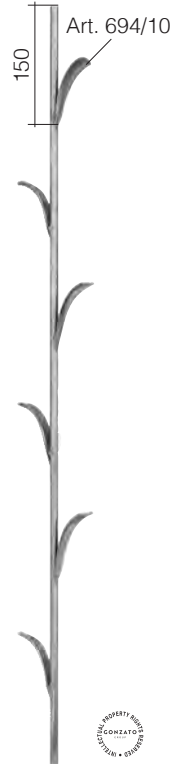

Art. GD92/2
Ø 12 mm
130 x 1000 mm

spheres - sfere 116/F/4 Ø 40 mm



Art. 1166/1
Ø 12 mm
H 900 mm

Art. 1166/2
Ø 12 mm
H 900 mm

Art. 1166/3
Ø 12 mm
H 900 mm

Art. 1166/4
Ø 12 mm
H 900 mm

Art. 1167/3
Ø 12 mm
H 1000 mm

Art. 1167/4
Ø 12 mm
H 1000 mm

Art. 1167/1
Ø 12 mm
H 1000 mm

Art. 1167/2
Ø 12 mm
H 1000 mm



Art. 715/1
Ø 12 mm
580 x H 880 mm
left - sinistro



left - sinistro

Art. 715/2
Ø 12 mm
580 x H 880 mm
right - destro

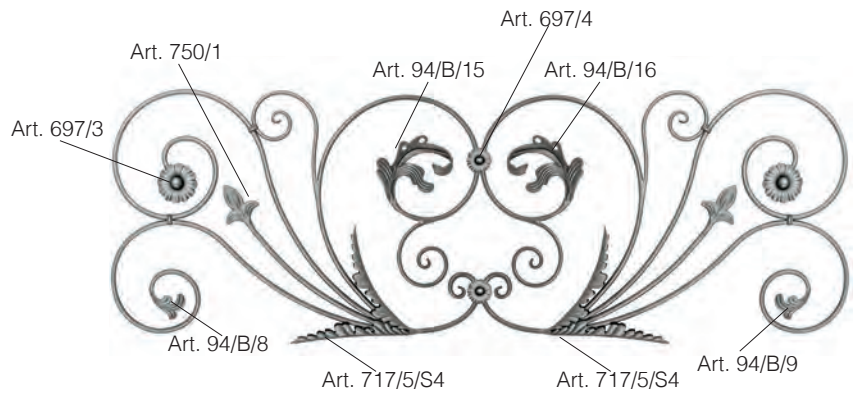

Art. 713/2
Ø 12 mm
1780 x H 580 mm



Art. 716/1
Ø 12 mm
920 x H 1280 mm
left - sinistro



left - sinistro

Art. 716/2
Ø 12 mm
920 x H 1280 mm
right - destro

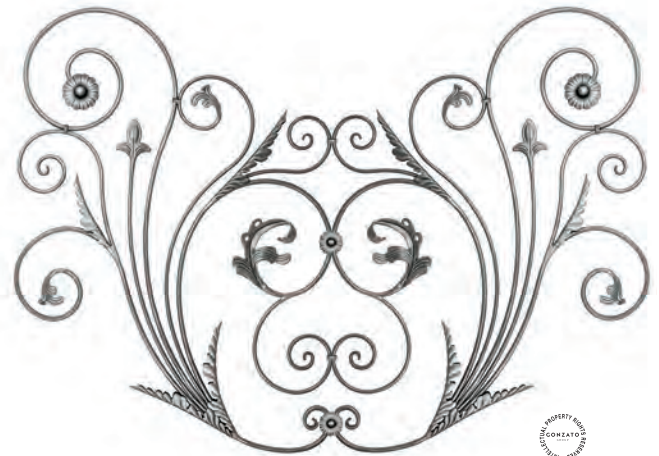

Art. 714/1
Ø 12 mm
1600 x H 1150 mm



Art. 716/3
Ø 12 mm
760 x H 890 mm
right - destro



left - sinistro

Art. 716/4
Ø 12 mm
760 x H 890 mm
left - sinistro



Art. 713/1
Ø 12 mm
1780 x H 760 mm



Art. 717/5/S1
H 285 mm
Ø 2 mm



Art. 717/5/S3
L 25 x H 290 mm
Ø 2 mm



Art. 696/3
H 430 x L 400 mm

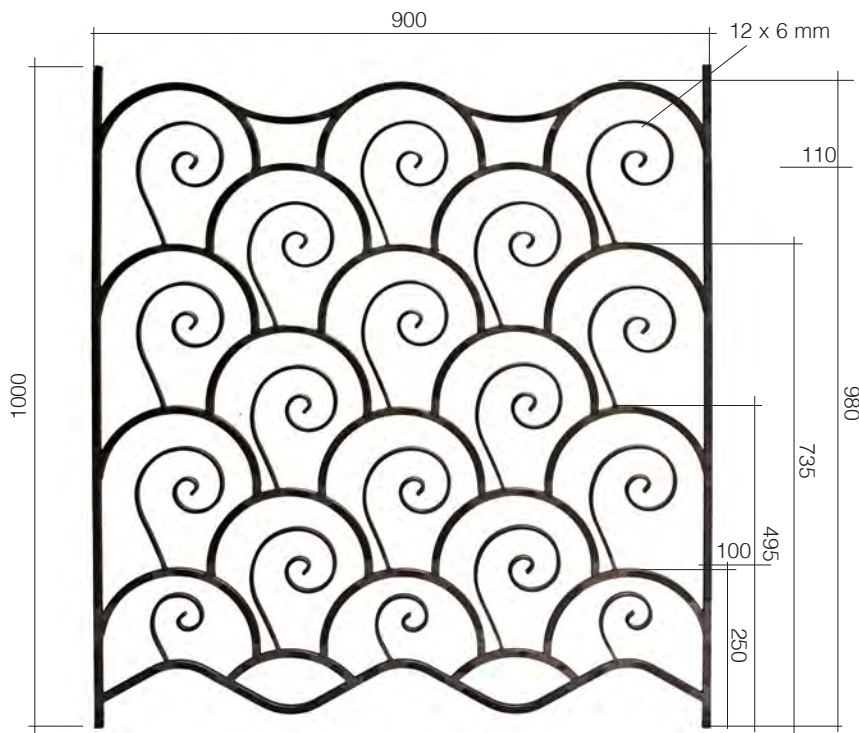

Art. GD291/2
□ 12 x 12 mm
900 x 1000 mm



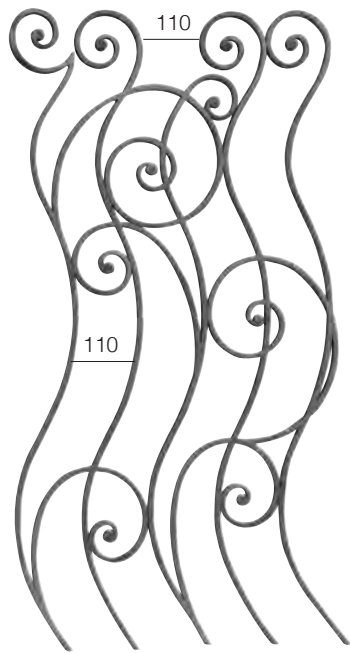

Art. GD226/3
 □ 14 x 8 mm
 535 x 1000 mm

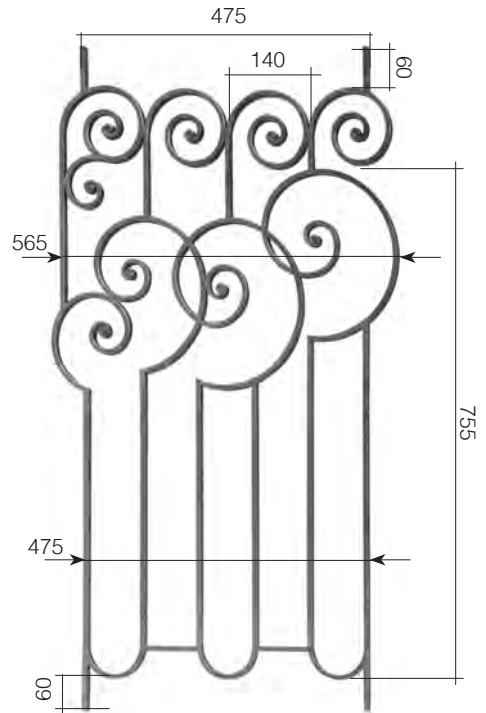

Art. GD228/1
 □ 14 x 8 mm
 580 x 1000 mm



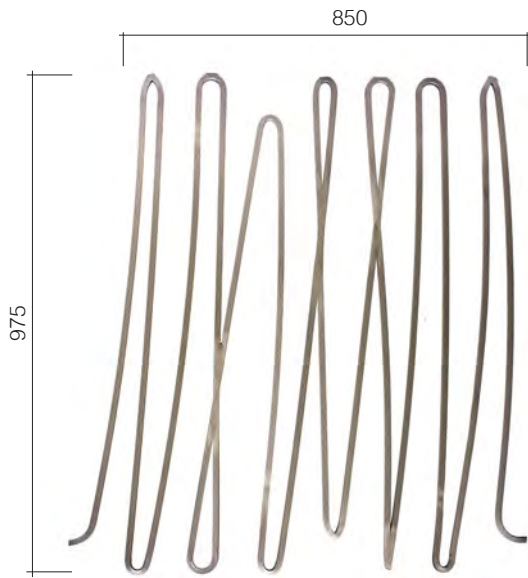

Art. GD300/1
Φ 12 x 12 mm
850 x 975 mm

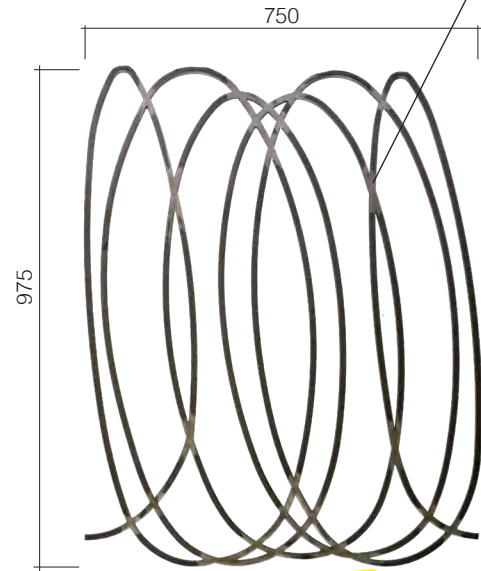

Art. GD300/2
Φ 12 x 12 mm
750 x 975 mm



Art. GD300/3
Φ 12 x 12 mm
465 x 975 mm



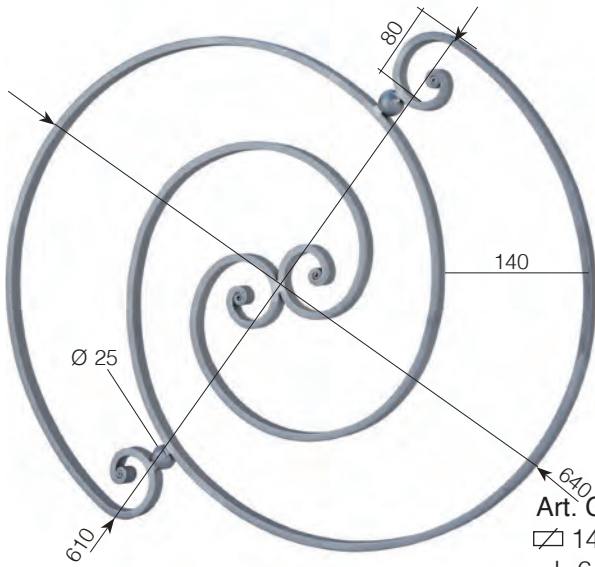

Art. GD285/1
□ 14 x 8 mm
L 640 mm
H 610 mm

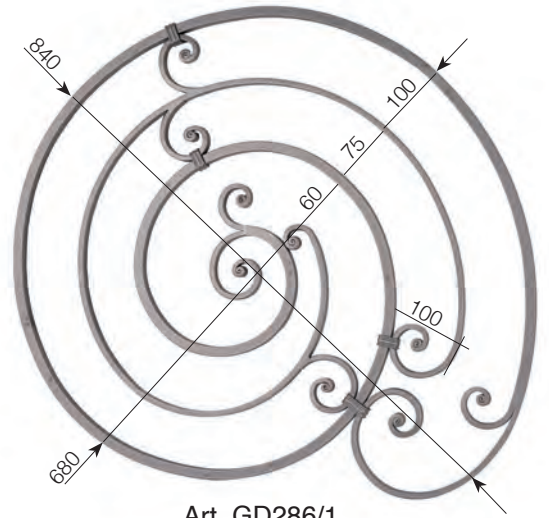

Art. GD286/1
□ 14 mm + □ 14 x 8 mm
L 840 mm
H 680 mm

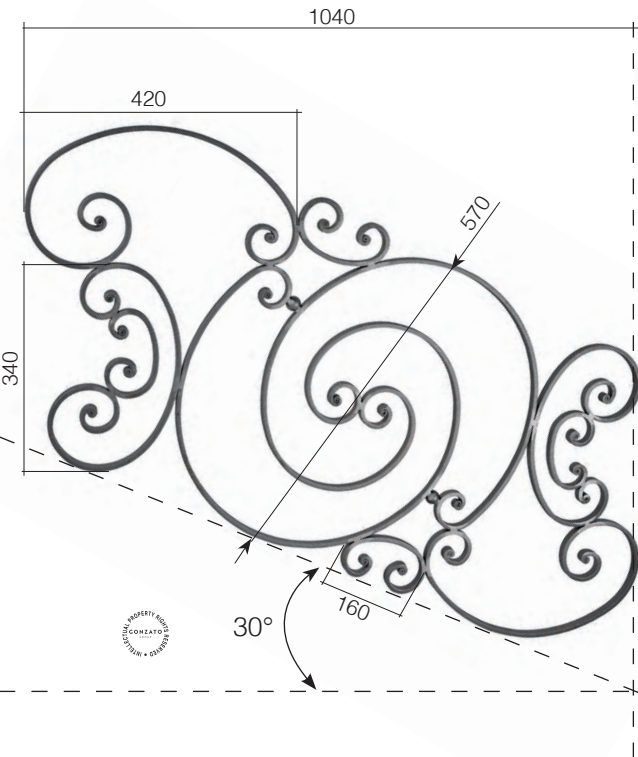

Art. GD231/2/S3
□ 14 x 8 mm
570 x 1200 mm

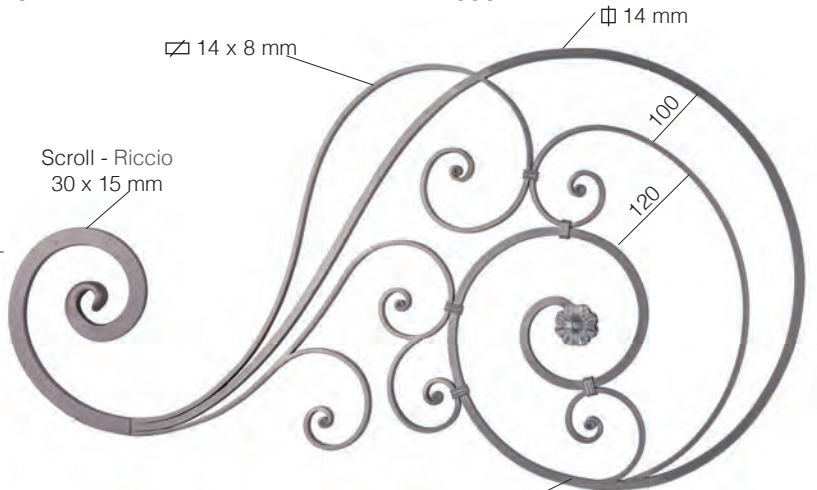

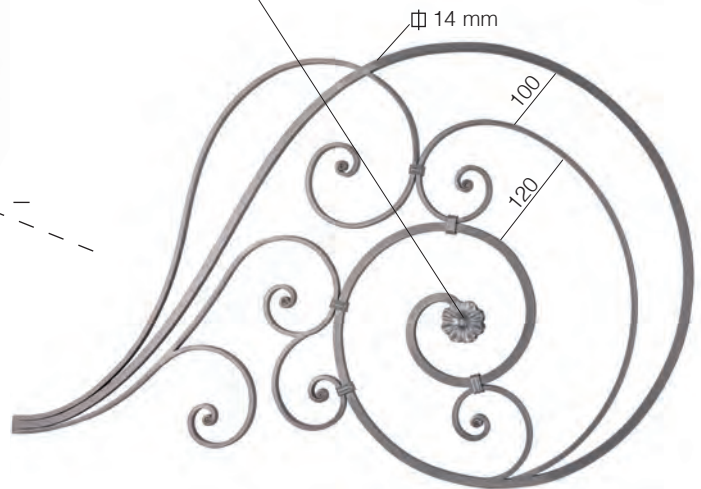

Art. GD285/2
□ 14 mm + □ 14 x 8 mm
L 1360 mm
H 700 mm

art. 116/A/4
on both sides
sui due lati



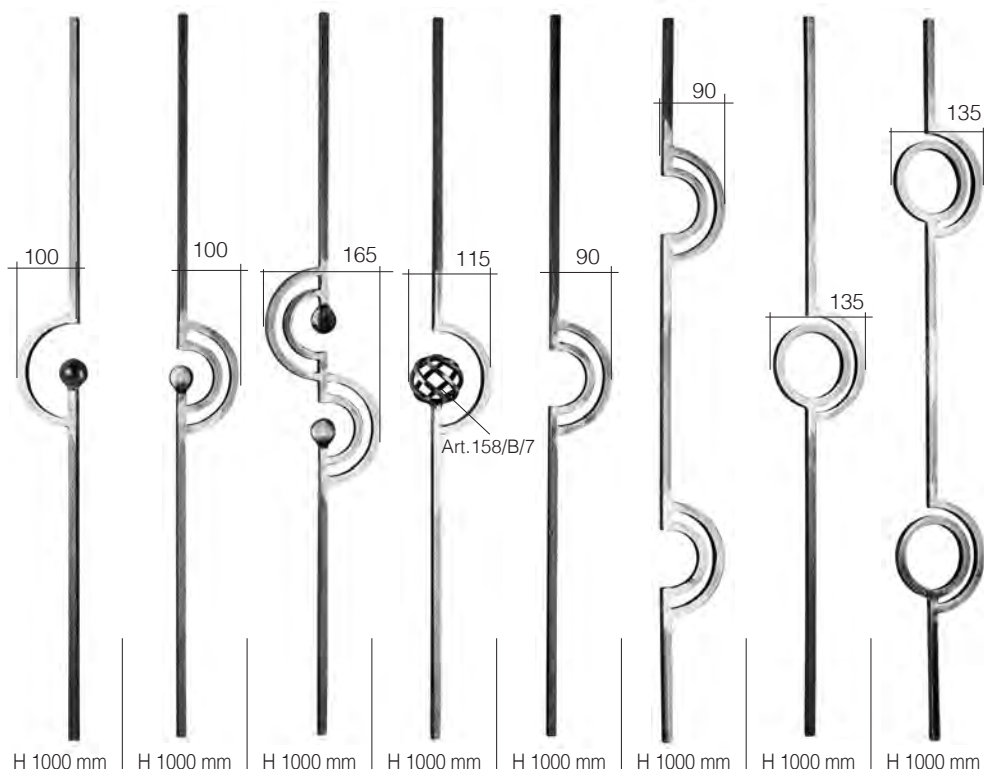

Art. GD285/5
□ 14 mm + □ 14 x 8 mm
L 1200 mm
H 700 mm

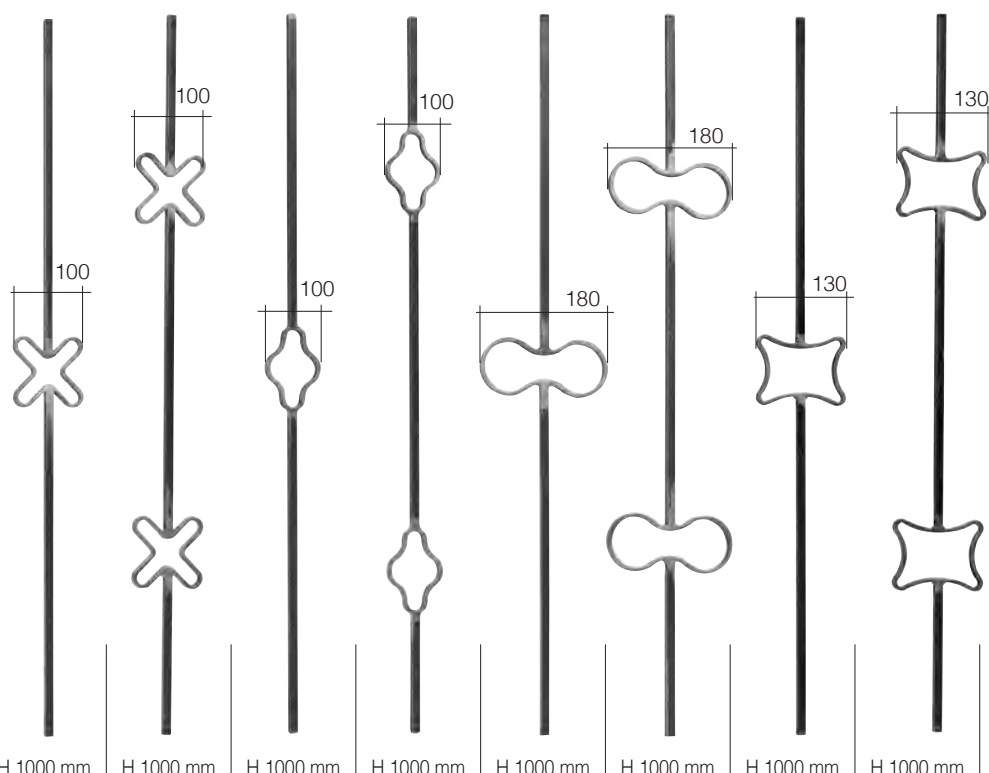

| Sec.Sez. | Finish - Finitura | Art. | Art. | Art. | Art. | Art. | Art. | Art. | |
|----------|--|--------|--------|--------|--------|--------|--------|--------|--------|
| Ø 12 mm | Plain Liscio  | 1089/1 | 1089/3 | 1089/4 | 1090/1 | 1090/3 | 1090/4 | 1091/1 | 1091/2 |

Ornaments - Ornamenti $\square 12 \times 6$ mm



| Sec.Sez. | Finish - Finitura | Art. | Art. | Art. | Art. | Art. | Art. | Art. |
|----------|---|---------|---------|--------|--------|--------|--------|--------|
| Ø 12 mm | Plain Liscio  | 1324/11 | 1324/12 | 1324/3 | 1324/4 | 1324/5 | 1324/6 | 1324/8 |



Art. GD187/1
 \varnothing 14 mm
 190 x 1000 mm

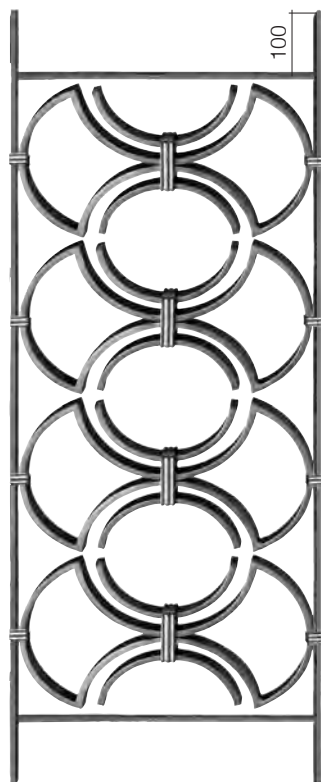

Art. GD189/2
 \varnothing 14 x 8 mm
 340 x 1000 mm

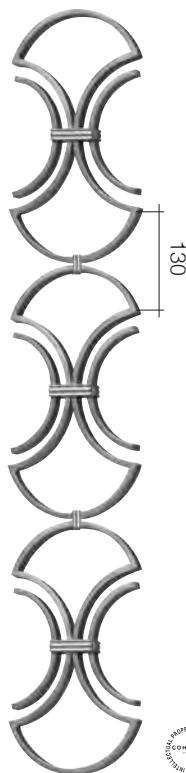

Art. GD189/1
 \varnothing 14 x 8 mm
 190 x 975 mm

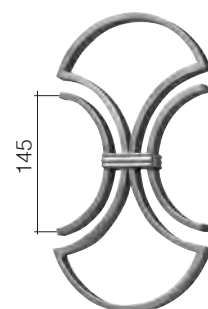

Art. GD187/2
 \varnothing 14 x 8 mm
 190 x 325 mm



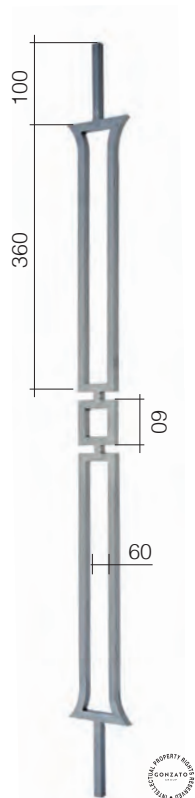

Art. GD78/4
Ø 12 mm
100 x 1000 mm

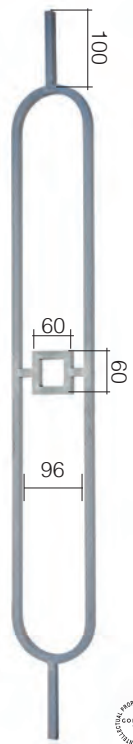

Art. GD78/6
Ø 12 mm
120 x 1000 mm



Art. 1084/3
Ø 12 x 12 mm
100 x 1000 mm



Art. 1084/4
Ø 12 x 12 mm
100 x 1000 mm

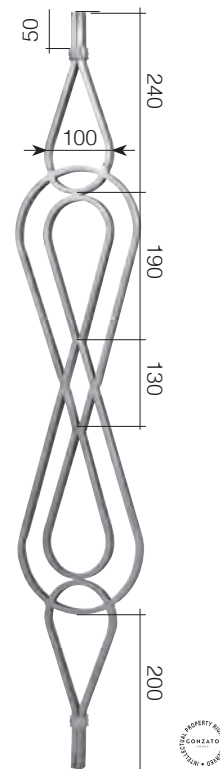

Art. GD171/1
Ø 14 x 8 mm
180 x 1000 mm



Art. 1074/1
Ø 10 mm
205 x 1000 mm



Art. 1074/2
Ø 10 mm
230 x 1000 mm



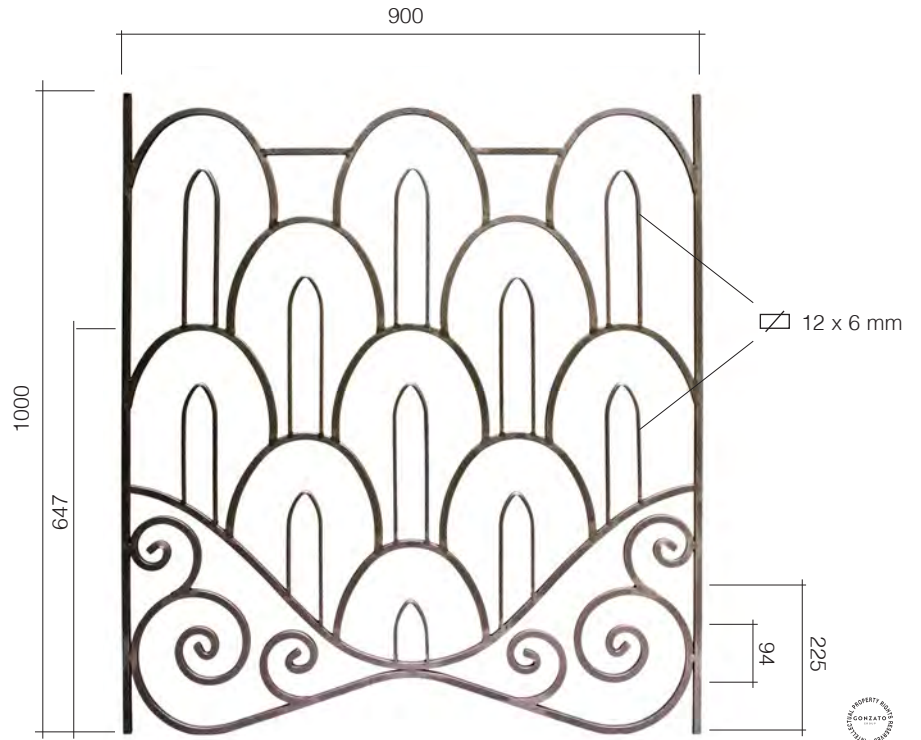

Art. GD291/1
 $\square 12 \times 12 \text{ mm} + \square 12 \times 6 \text{ mm}$
 900 x 1000 mm

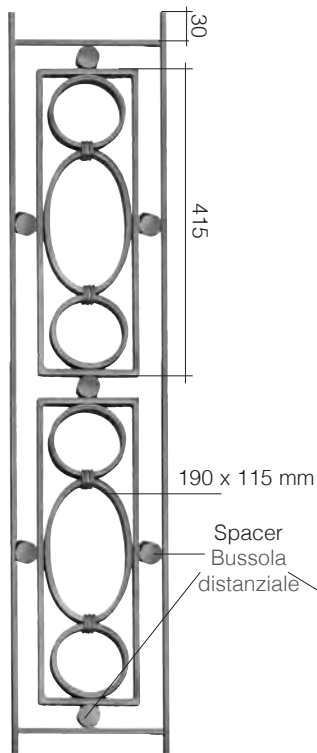

Art. GD205/2
 $\square 14 \times 8 \text{ mm}$
 210 x 1000 mm

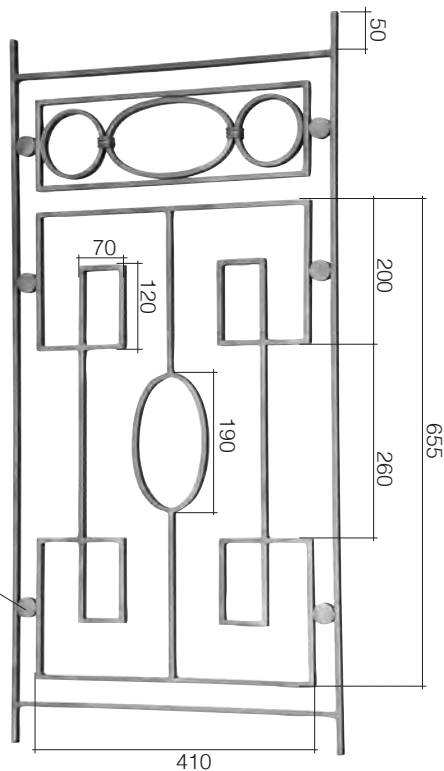

Art. GD205/1
 $\square 14 \times 8 \text{ mm}$
 495 x 1000 mm

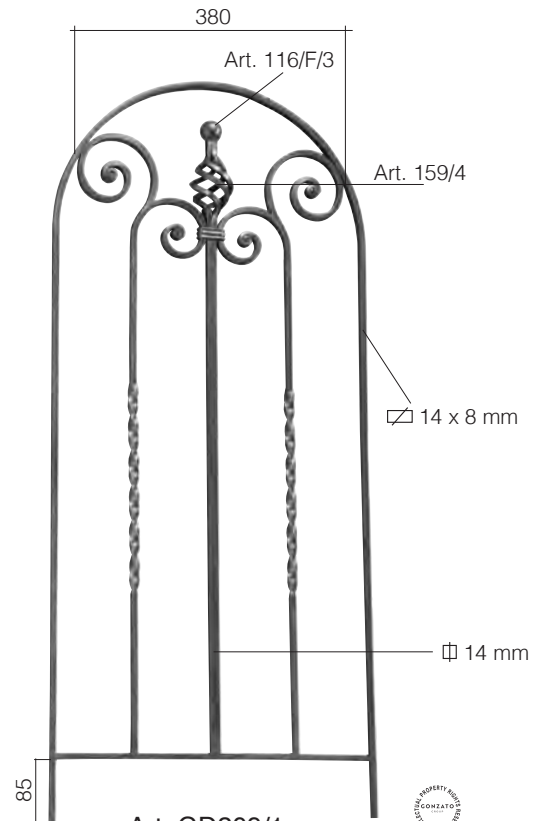

Art. GD209/1
 $\square 14 \times 8 \text{ mm}$
 440 x 1000 mm



Tubular steel frame \varnothing 25 x 25 mm - Insert iron solid \varnothing 12 x 12 mm
Struttura-telaio tubo \varnothing 25 x 25 mm - Inserti \varnothing 12 x 12 mm

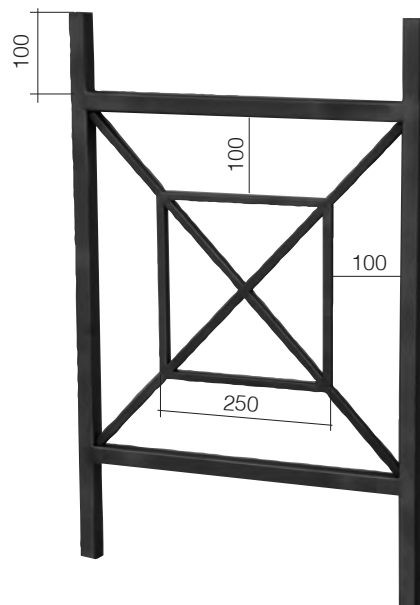

Art. GD76/2
H 700 mm
L 500 mm

Rosettes 116/A/4 on both sides - Rosette 116/A/4 sui 2 lati

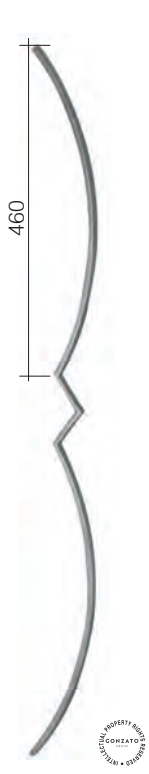

Art. GD12/1
□ 14 x 8 mm
95 x 1000 mm

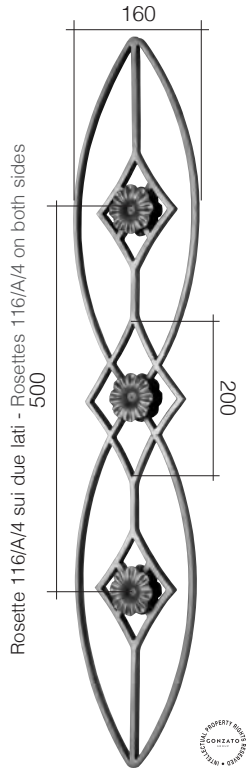

Rosette 116/A/4 sui due lati - Rosettes 116/A/4 on both sides

Art. GD15/1
□ 14 x 8 mm
190 x 1000 mm

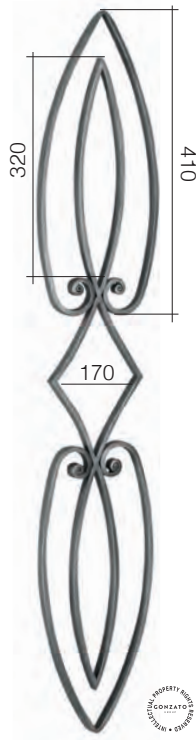

Art. GD15/2
□ 14 x 8 mm
190 x 1000 mm

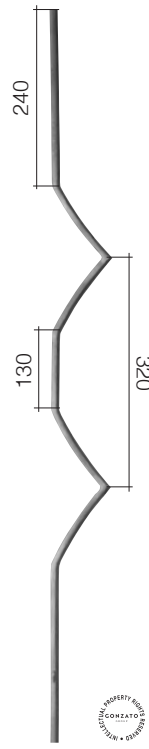

Art. GD18/3
□ 14 x 8 mm
85 x 1000 mm

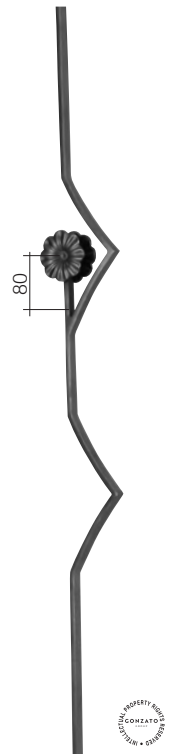

Art. GD18/4
□ 14 x 8 mm
115 x 1000 mm

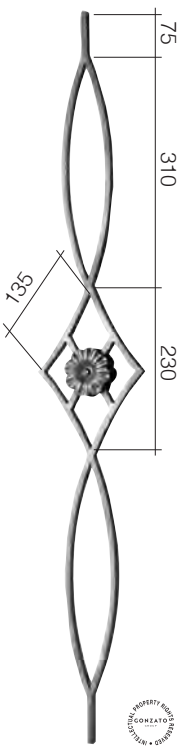

Art. GD16/2
□ 14 x 8 mm
160 x 1000 mm

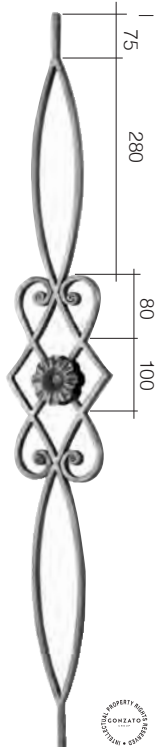

Art. GD16/1
□ 14 x 8 mm
160 x 1000 mm

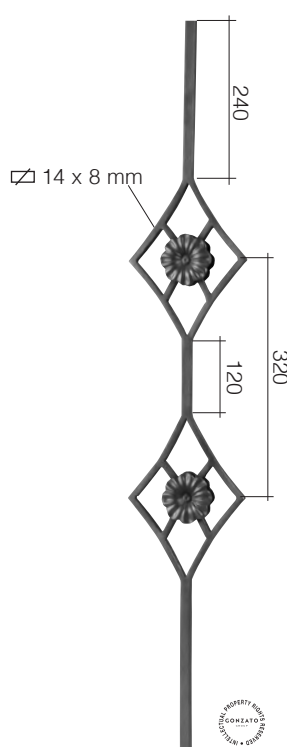

Art. GD18/1
□ 14 mm
160 x 1000 mm

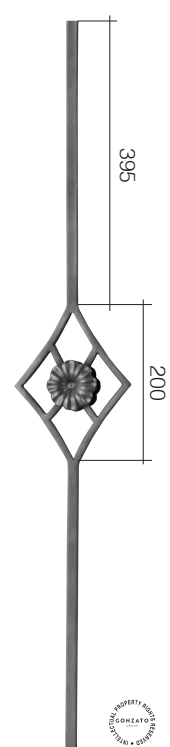

Art. GD18/2
□ 14 mm
160 x 1000 mm

Rosettes 116/A/4 on both sides - Rosette 116/A/4 sui 2 lati

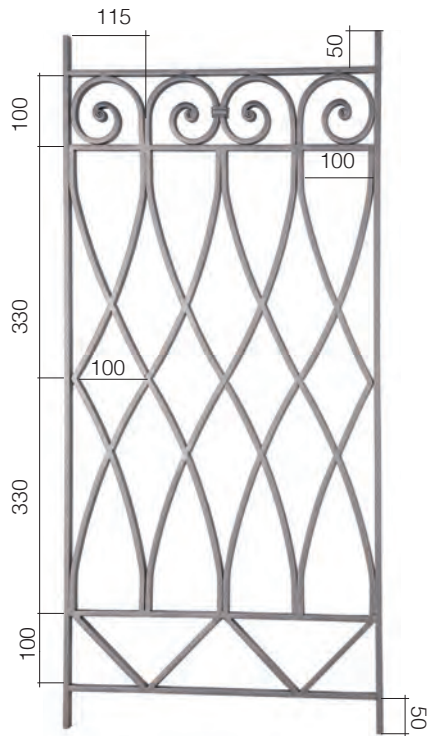

Art. GD283/1
 □ 14 x 8 mm
 480 x 1000 mm

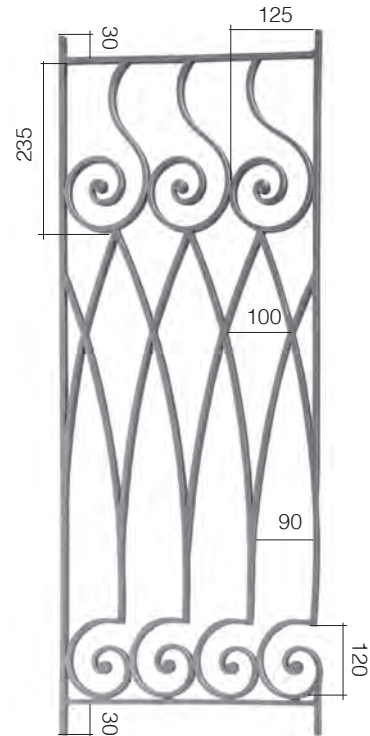

Art. GD220/2
 □ 14 x 8 mm
 395 x 1000 mm

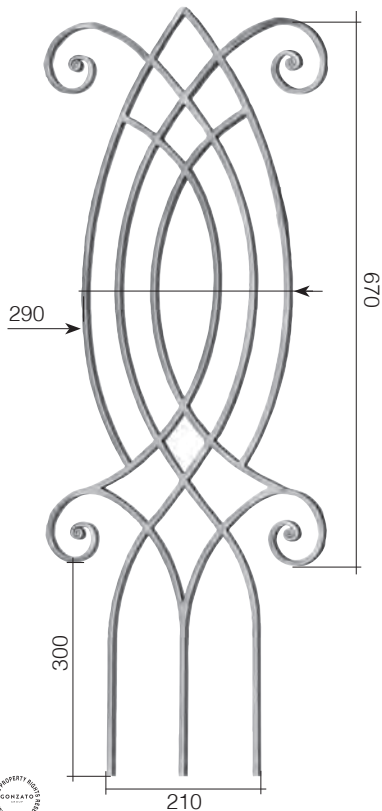

Art. GD234/1
 □ 14 x 8 mm
 380 x 1000 mm

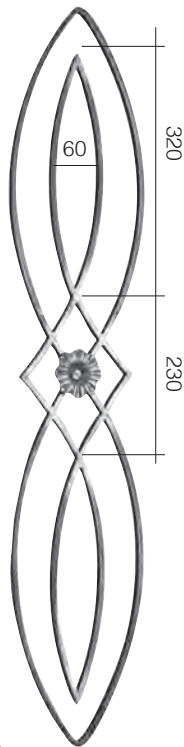

Art. 1680/2
 □ 14 x 8 mm
 190 x 1000 mm

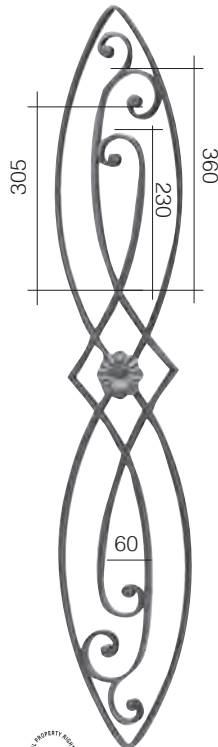

Art. 1681/1
 □ 14 x 8 mm
 190 x 1000 mm



Ornaments - Ornamenti \varnothing 12 x 6 mm

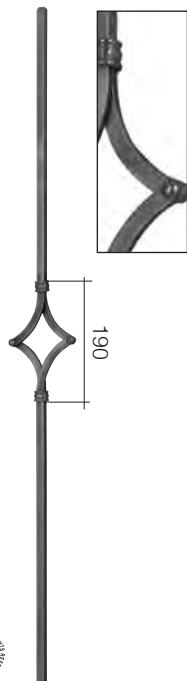

Art. GD20/1
 \varnothing 12 mm
110 x 1000 mm

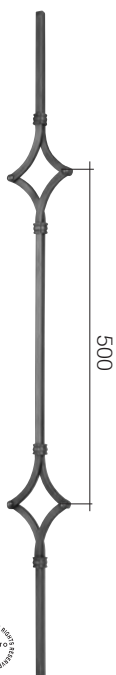

Art. GD20/2
 \varnothing 12 mm
110 x 1000 mm

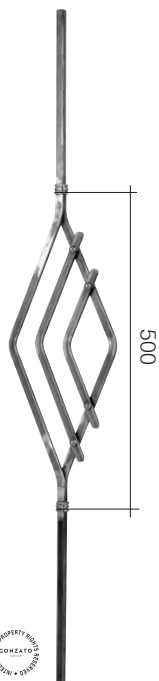

Art. GD20/3
 \varnothing 12 mm
180 x 1000 mm



Art. GD20/4
 \varnothing 12 mm
200 x 1000 mm

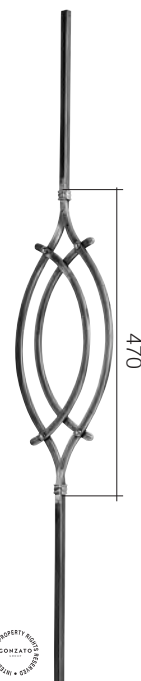

Art. GD20/5
 \varnothing 12 mm
180 x 1000 mm

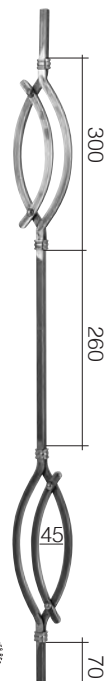

Art. GD20/6
 \varnothing 12 mm
100 x 1000 mm

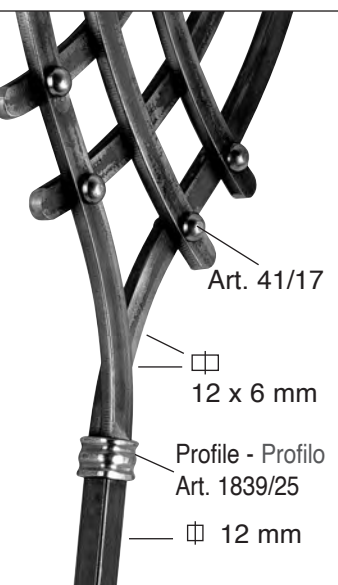

Art. GD20/7
 \varnothing 12 mm
100 x 1000 mm

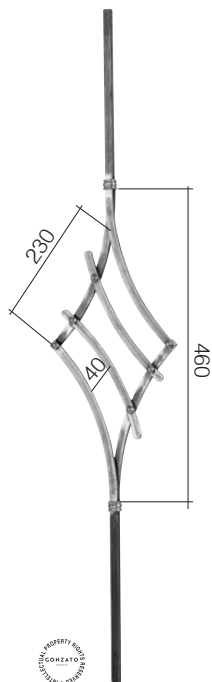

Art. GD20/8
 \varnothing 12 mm
200 x 1000 mm



Ornaments - Ornamenti \square 12 x 6 mm

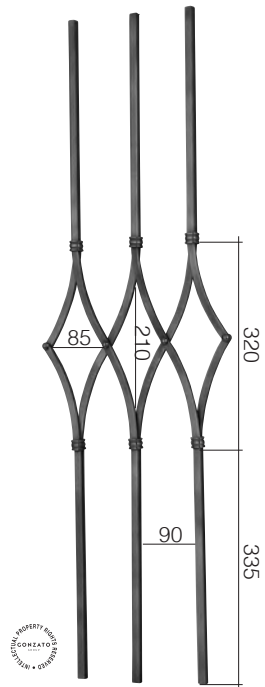

Art. GD21/1
 \square 12 mm
315 x 1000 mm

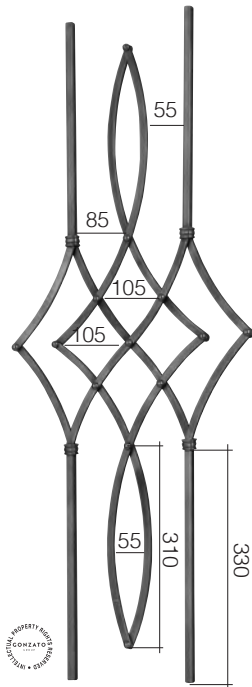

Art. GD21/2
 \square 12 mm
415 x 1000 mm

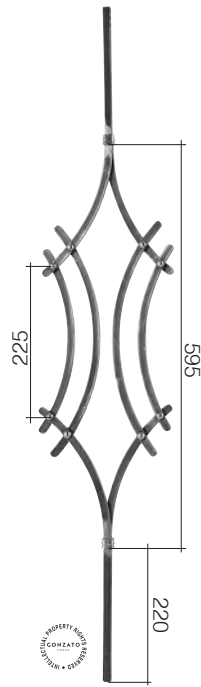

Art. GD21/3
 \square 12 mm
200 x 1000 mm

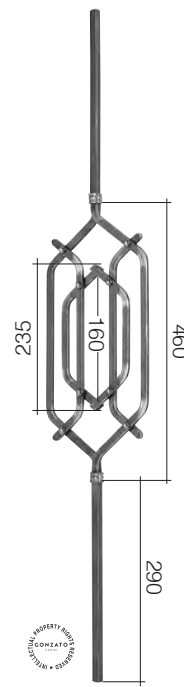

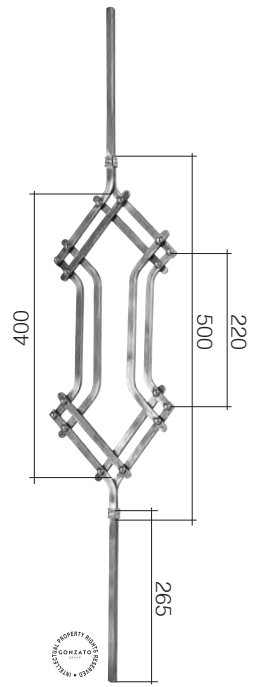

Art. GD21/4
 \square 12 mm
180 x 1000 mm



Art. GD21/5
 \square 12 mm
200 x 1000 mm

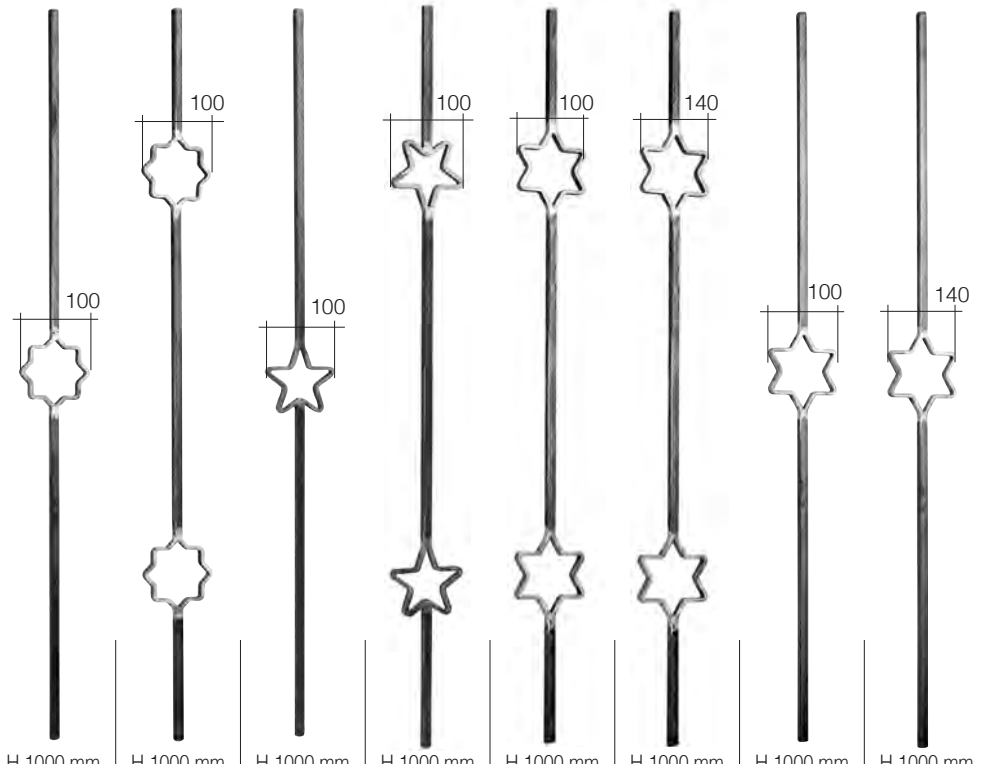



| Sec.Sez. | Finish - Finitura | Art. | Art. | Art. | Art. | Art. | Art. | Art. | Art. |
|----------|--|--------|--------|--------|--------|--------|---------|--------|--------|
| Ø 12 mm | Plain Liscio  | 1325/3 | 1325/4 | 1325/5 | 1325/6 | 1325/8 | 1325/10 | 1325/7 | 1325/9 |



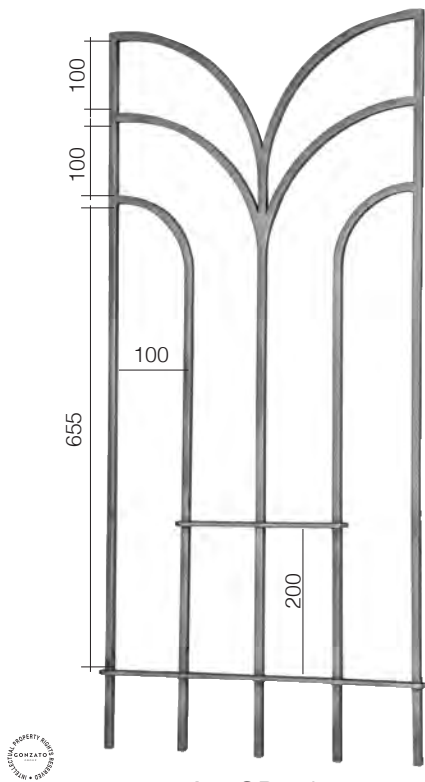

Art. GD68/1
 Φ 12 x 12 mm
 480 x 1000 mm

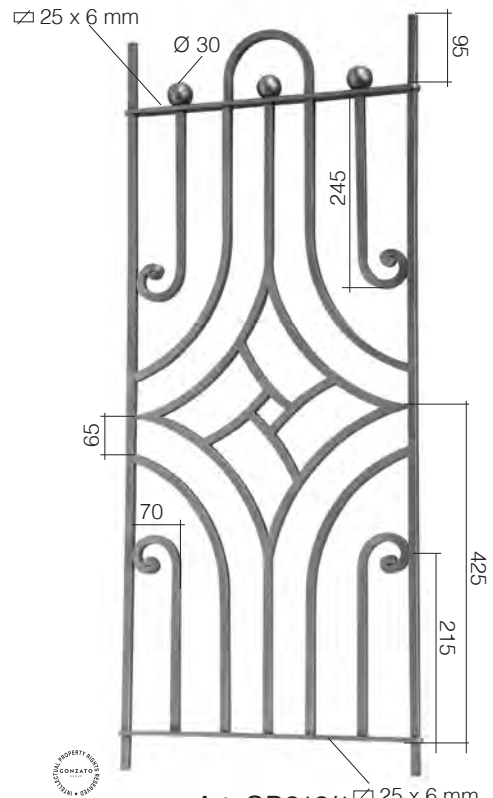

Art. GD212/1
 Φ 12 x 12 mm
 420 x 1000 mm

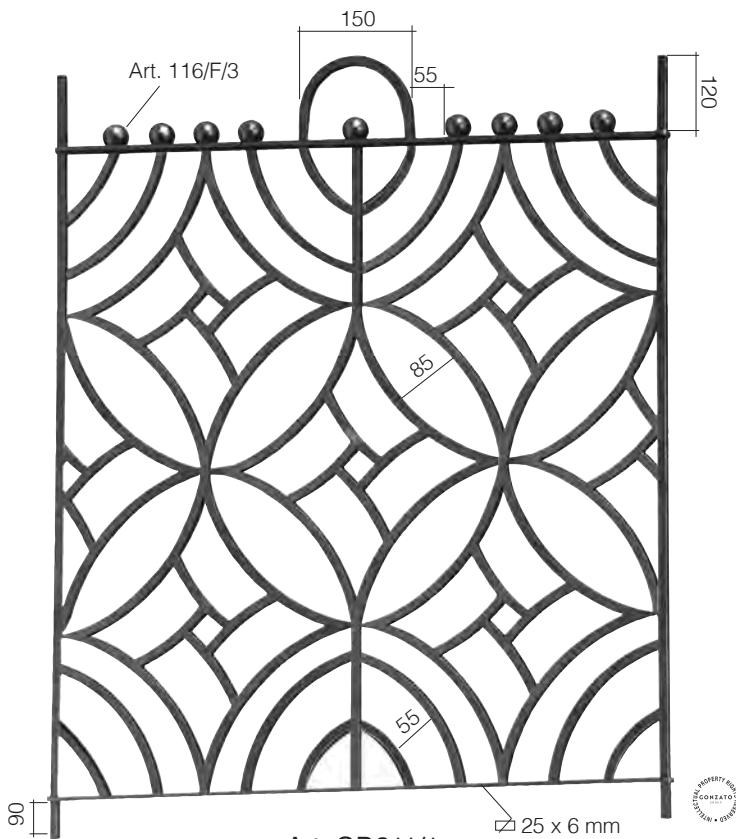

Art. GD211/1
 Φ 12 x 12 mm
 830 x 1000 mm

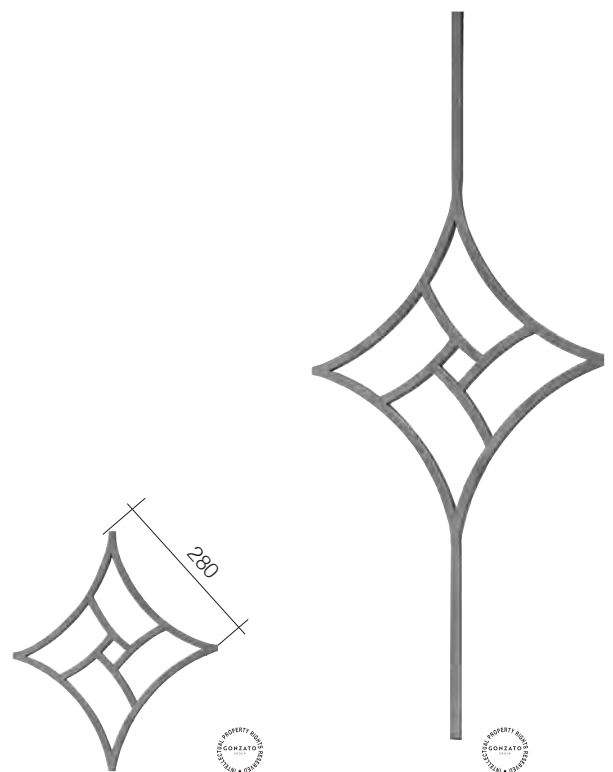

Art. GD211/2
 Φ 12 mm
 395 x 395 mm



Art. GD211/3
 Φ 12 mm
 395 x 1000 mm

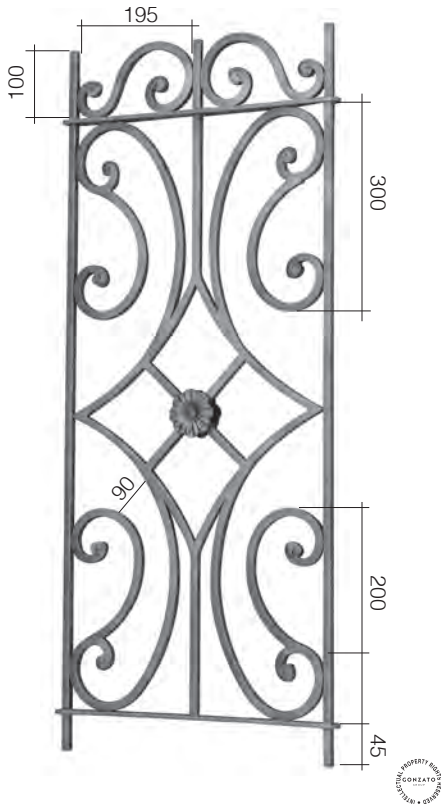

Art. GD61/1
Ø 12 x 12 mm
430 x 1000 mm

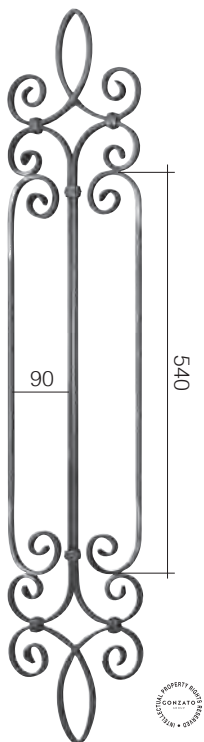

Art. GD35/2
Ø 12 x 6 mm
200 x 1000 mm

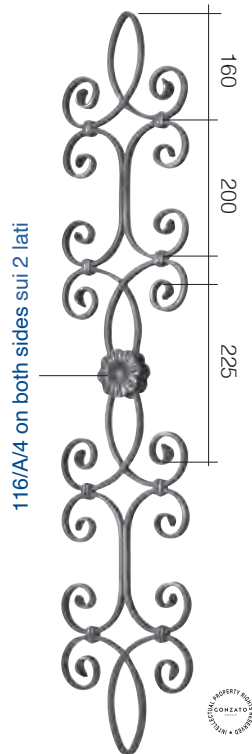

Art. GD35/1
Ø 12 x 6 mm
200 x 1000 mm

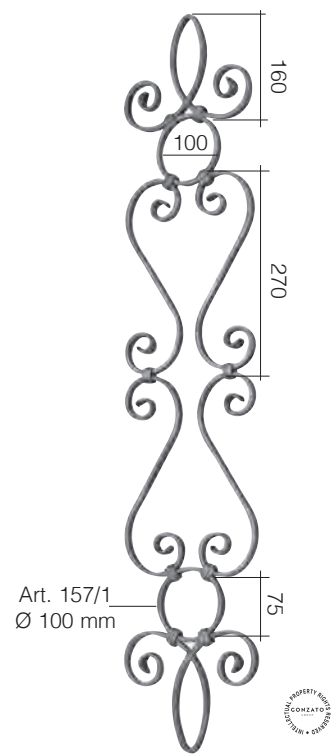

Art. GD35/3
Ø 12 x 6 mm
200 x 1000 mm

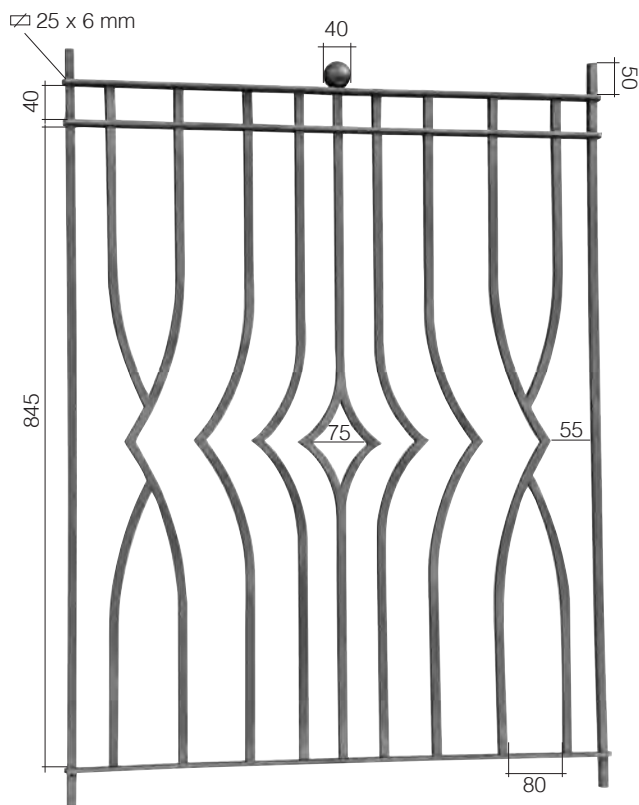

Art. GD232/1
 \varnothing 12 x 12 mm
 740 x 1000 mm

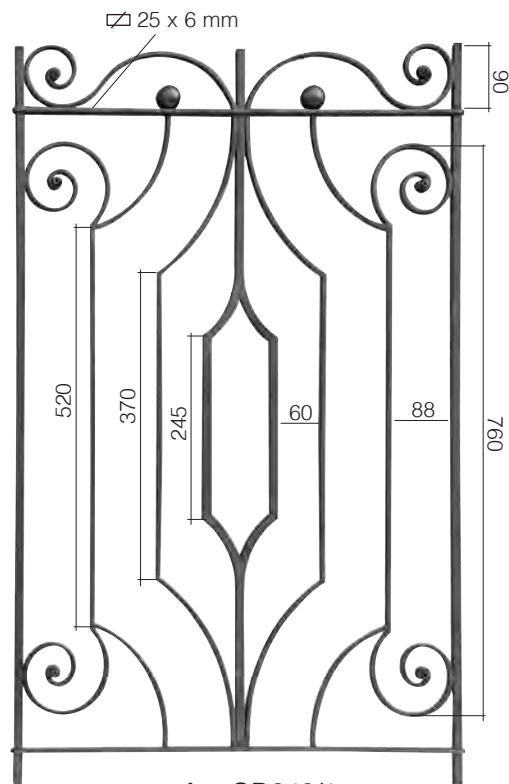

Art. GD242/1
 \varnothing 12 x 12 mm
 640 x 1000 mm



116/A/4 on both sides sui 2 lati

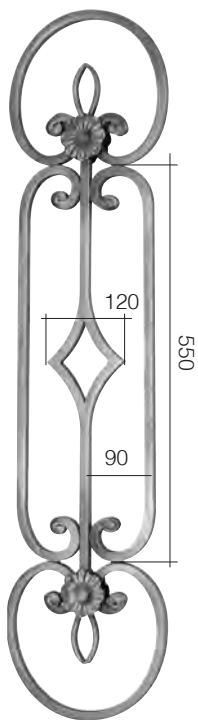

Art. GD31/1
 \varnothing 14 x 14 mm
 245 x 1000 mm

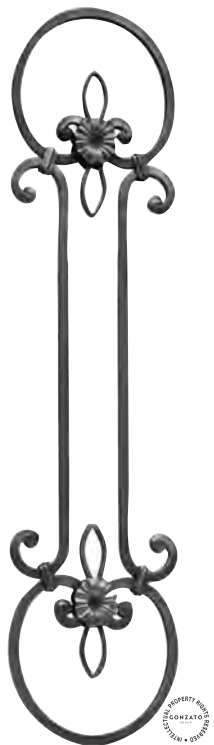

Art. 1682/1
 \varnothing 14 x 14 mm
 245 x 1000 mm

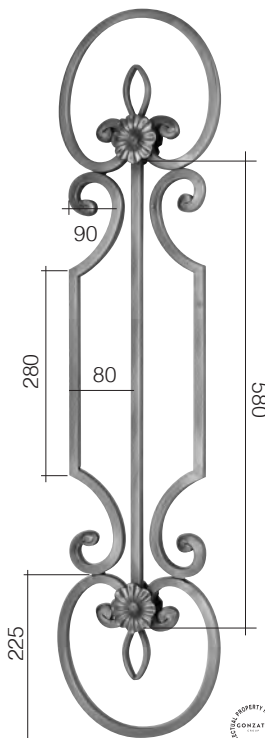

Art. GD31/2
 \varnothing 14 x 14 mm
 245 x 1000 mm



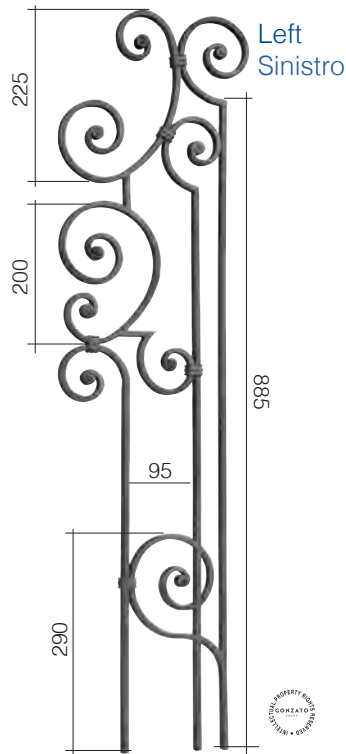

left - sinistro
Art. GD163/2
□ 14 x 8 mm
L 280 mm
H 1000 mm

right - destro
Art. GD163/1
□ 14 x 8 mm
L 280 mm
H 1000 mm

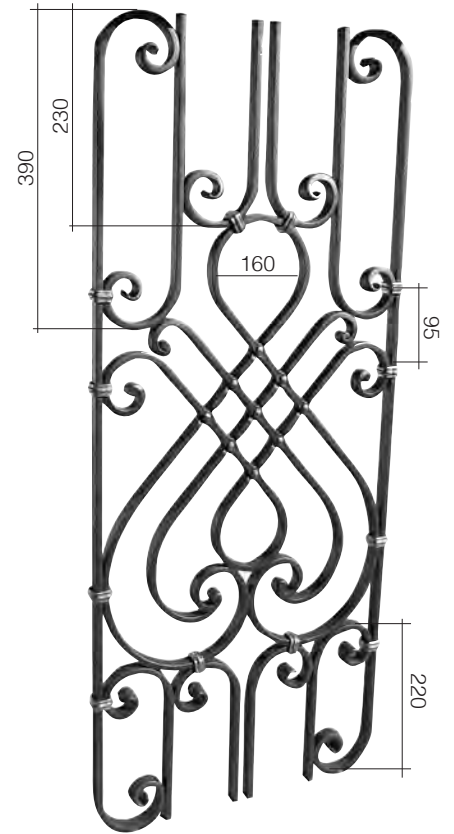

Art. GD99/1
□ 16 x 8 mm
420 x 1000 mm

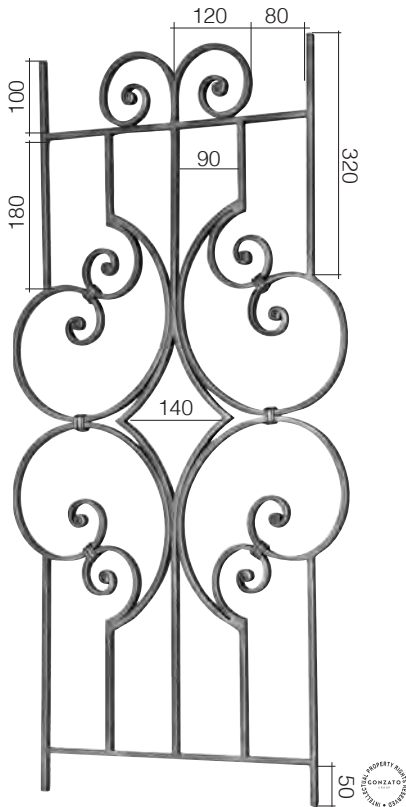

Art. GD219/1
□ 14 x 8 mm
500 x 1000 mm



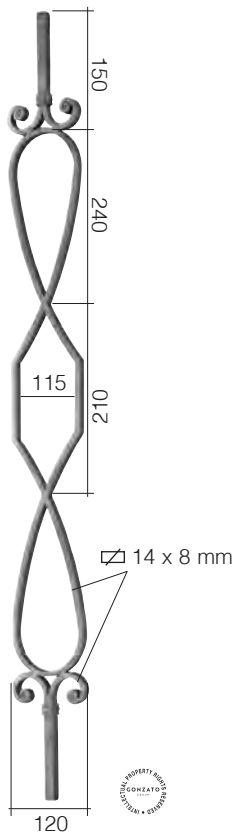

Art. GD178/1
 \varnothing 14 mm
 120 x 1000 mm

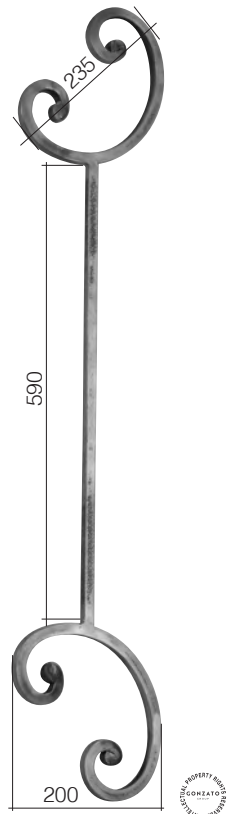

Art. GD22/5
 \varnothing 14 mm
 200 x 1000 mm

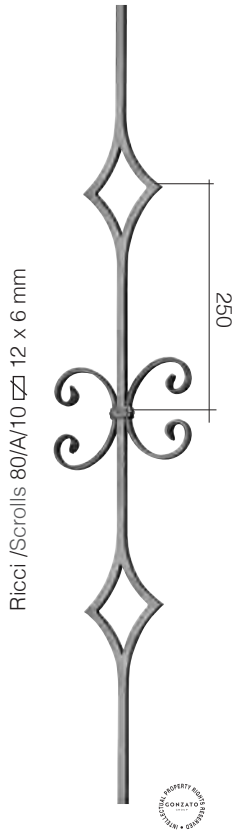

Ricci/Scrolls 80/A/10 \varnothing 12 x 6 mm

Art. GD59/3
 \varnothing 12 mm
 200 x 1000 mm

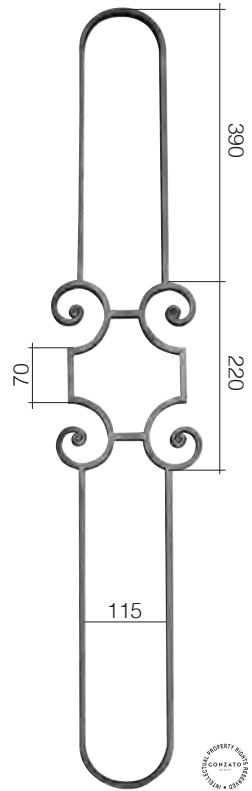

Art. GD245/3
 \varnothing 14 x 8 mm
 180 x 1000 mm

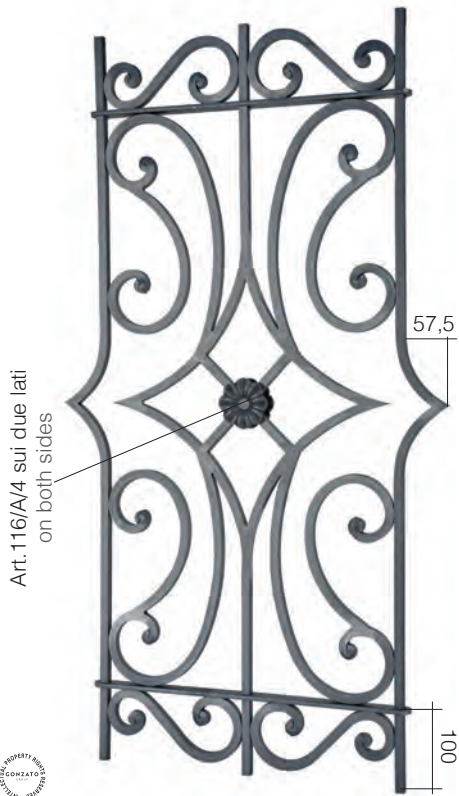

Art. GD61/3
 \varnothing 12 mm
 515 x 1000 mm

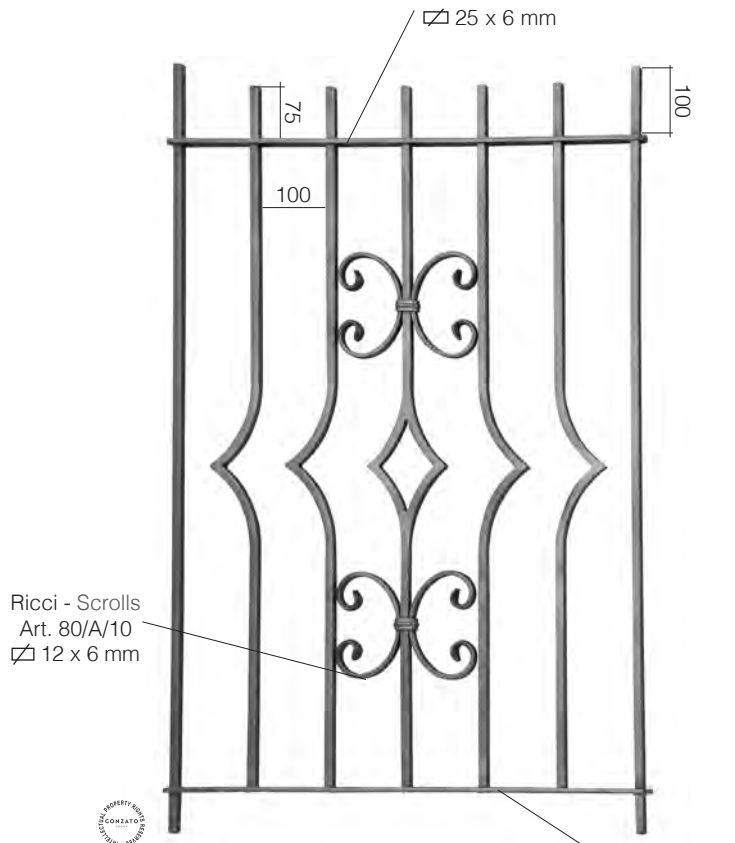

Art. GD58/1
 \varnothing 12 mm
 685 x 1000 mm

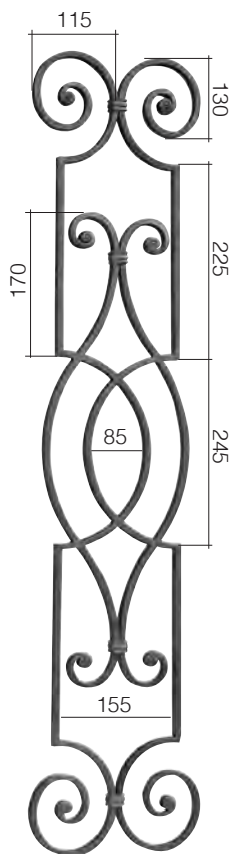
Sfere/ Spheres Ø 25 mm
Art. 116/F/2

Art. GD173/1
 □ 14 x 8 mm
 230 x 1000 mm

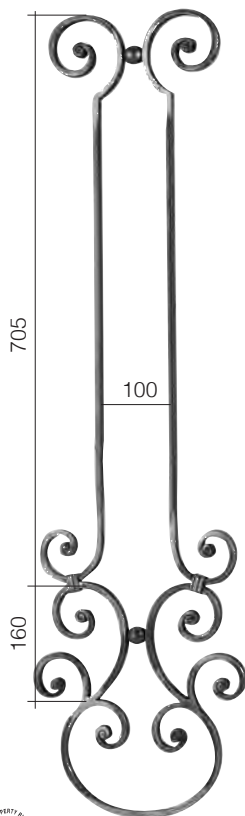

Art. GD159/1
 □ 14 x 8 mm
 280 x 1000 mm

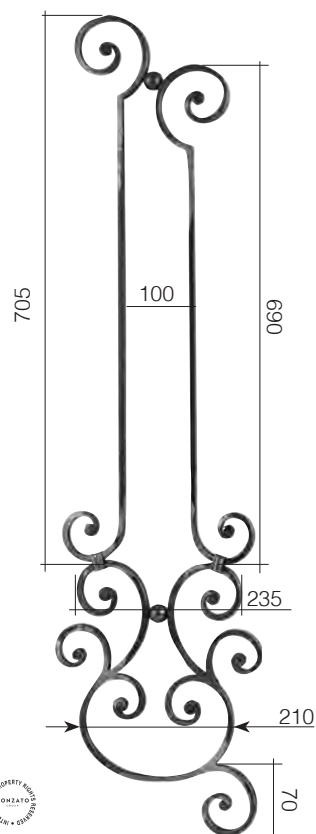

Art. GD159/2
 □ 14 x 8 mm
 280 x 1000 mm





420
Art. GD216/1
□ 14 x 8 mm
470 x 1000 mm

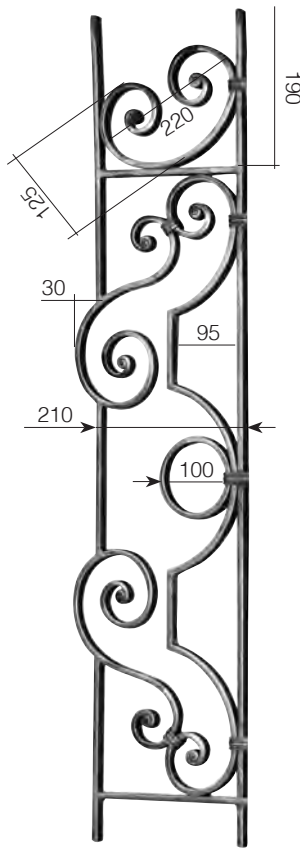

Art. GD216/2
□ 14 x 8 mm
240 x 1000 mm

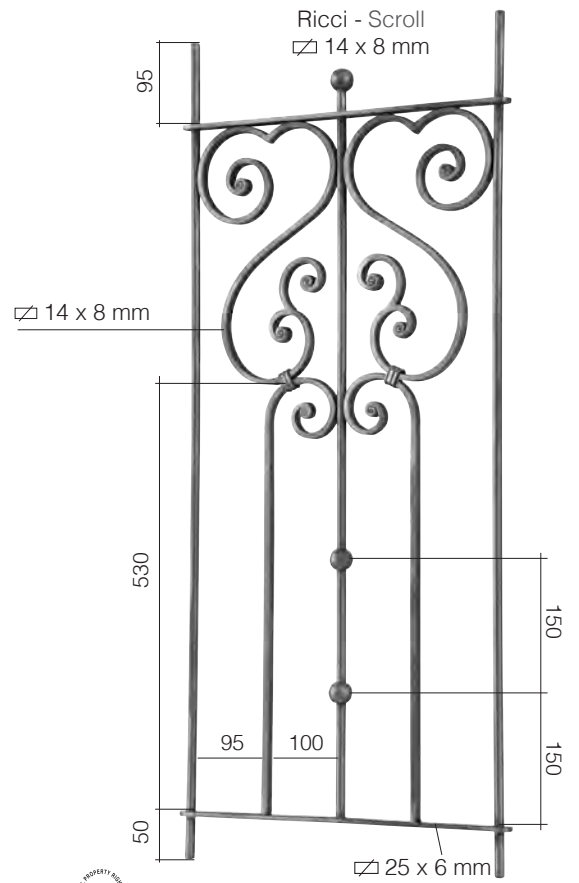

Art. GD241/1
Ø 12 mm
450 x 1000 mm

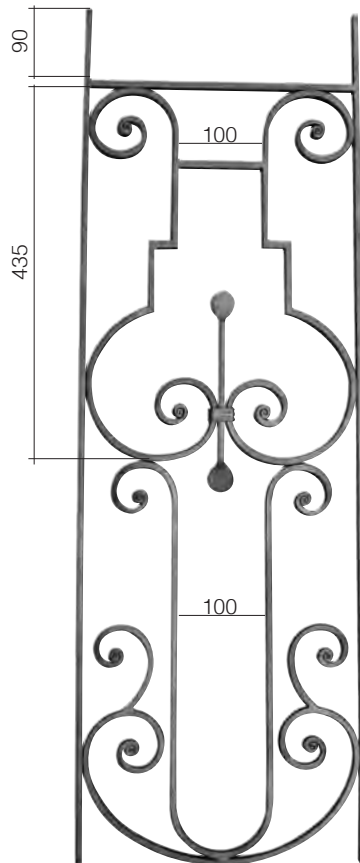

Art. GD245/1
□ 14 x 8 mm
330 x 1000 mm

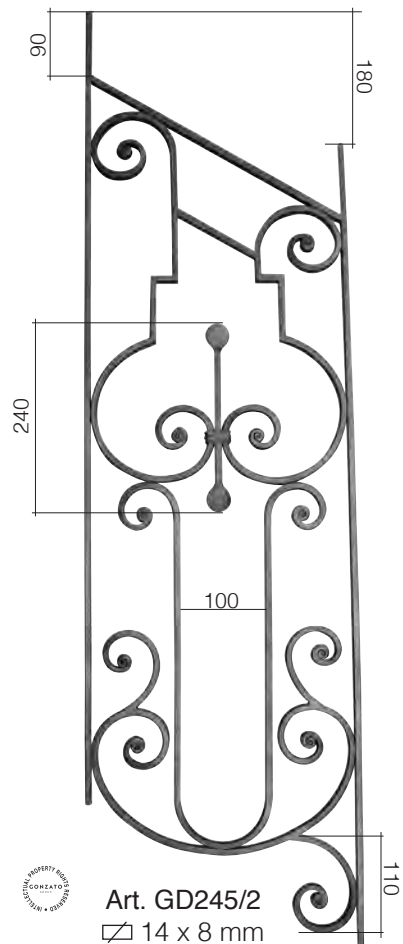

Art. GD245/2
□ 14 x 8 mm
330 x 1000 mm



Art. GD236/1
 □ 14 x 8 mm
 970 x 1000 mm

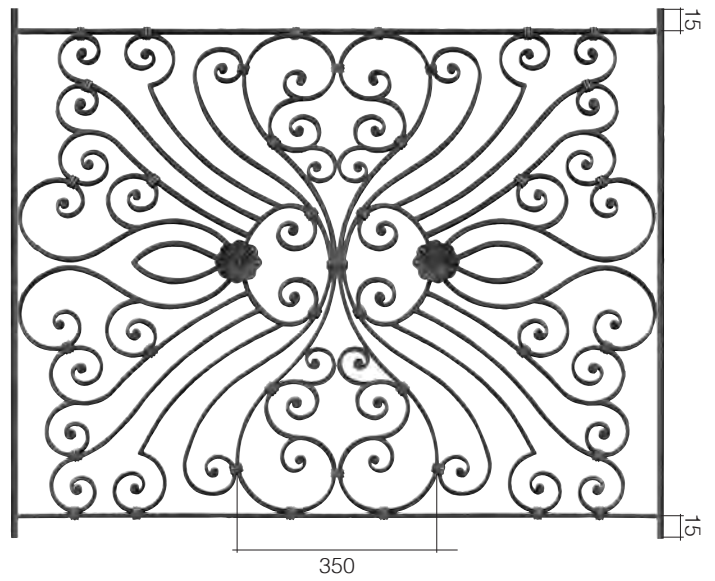

Art. GD239/1
 □ 14 x 8 mm
 1185 x 1000 mm



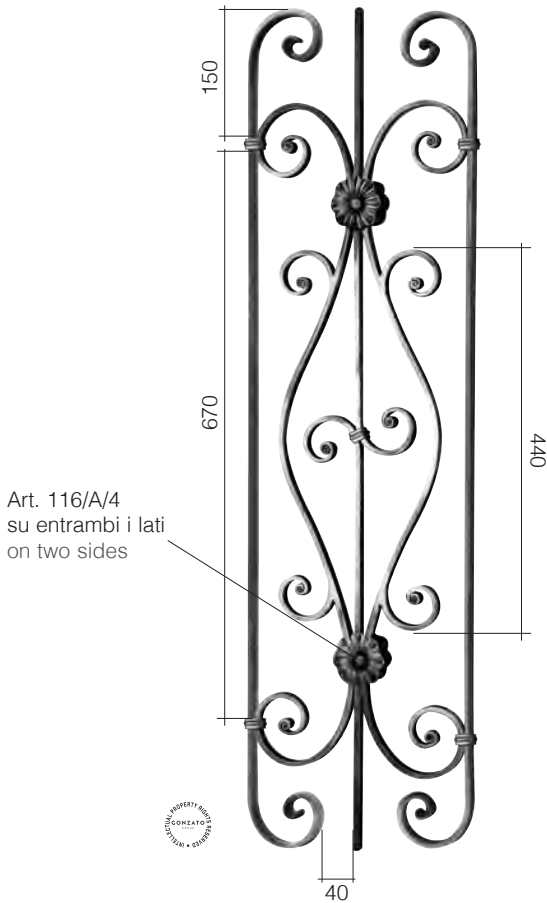

Art. 116/A/4
su entrambi i lati
on two sides



Art. GD105/1
□ 14 x 8 mm
275 x 1000 mm

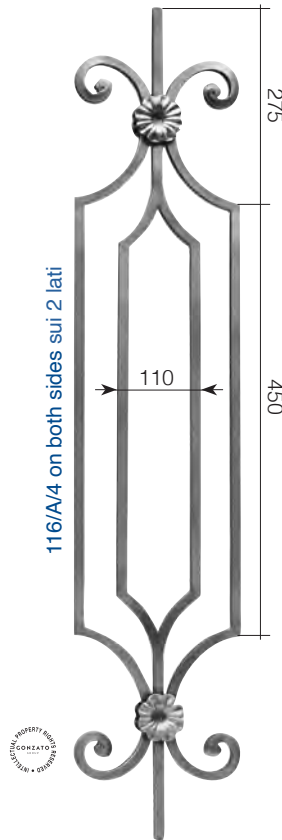

116/A/4 on both sides sui 2 lati



Art. 1685/3
□ 14 x 14 mm
230 x 1000 mm

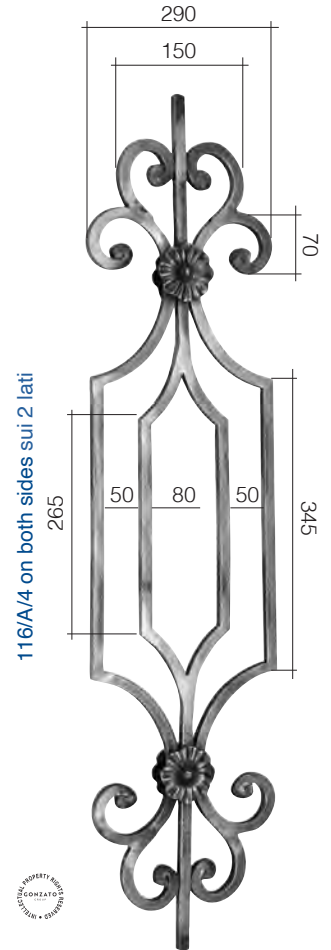

116/A/4 on both sides sui 2 lati



Art. GD22/1
□ 14 x 14 mm
230 x 1000 mm

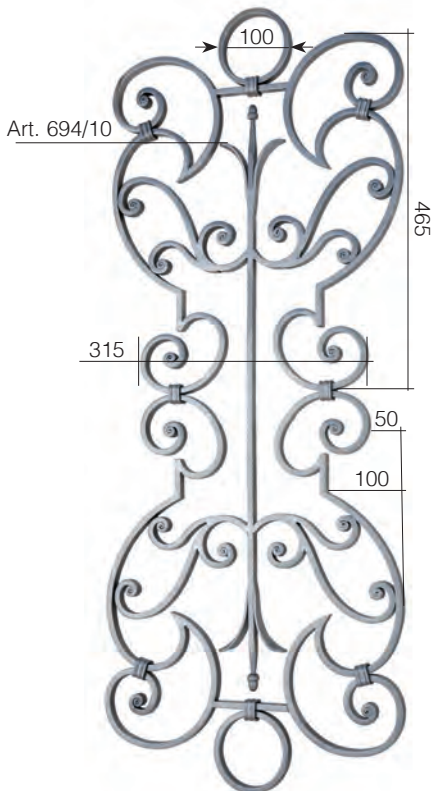

Art. 694/10

Art. GD282/2
□ 14 x 8 mm
405 x 1010 mm



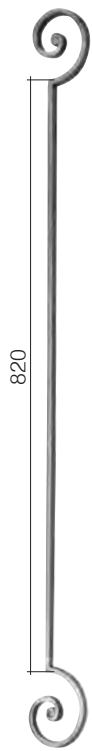

Art. GD175/3
□ 14 x 8 mm
80 x 1000 mm

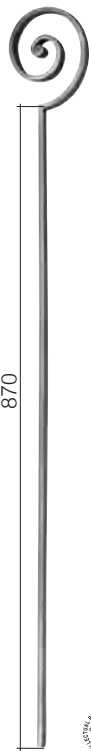

Art. GD175/4
□ 14 x 8 mm
115 x 1000 mm



Art. GD175/5
□ 14 x 8 mm
105 x 1000 mm

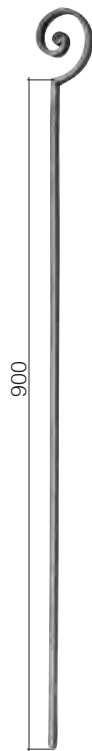

Art. GD175/6
□ 14 x 8 mm
85 x 1000 mm

BEST PRICE



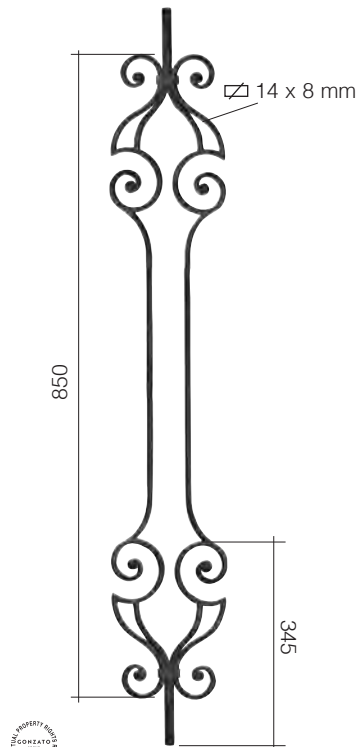

Art. GD150/2
Ø 14 x 14 mm
205 x 1000 mm

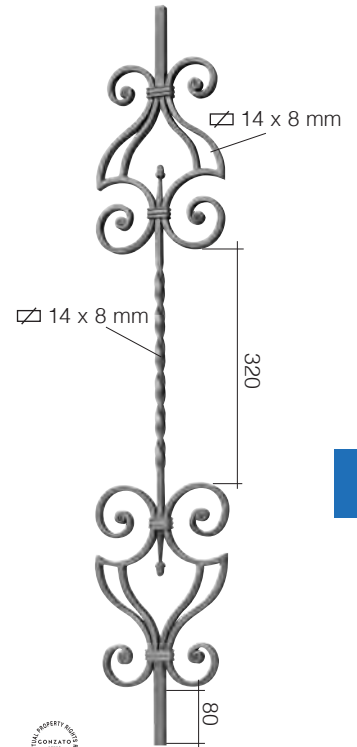

Art. GD150/3
Ø 14 x 14 mm
205 x 1000 mm

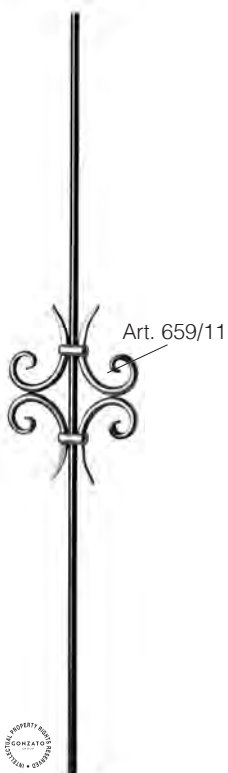

Art. 1066/5
Ø 12 mm
180 x 1000 mm



Art. 1066/4
Ø 12 mm
180 x 1000 mm

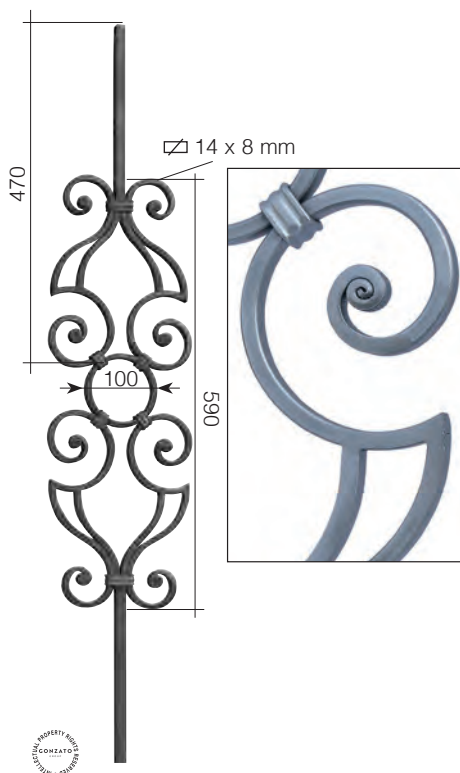

Art. GD151/1
Ø 14 x 14 mm
205 x 1000 mm

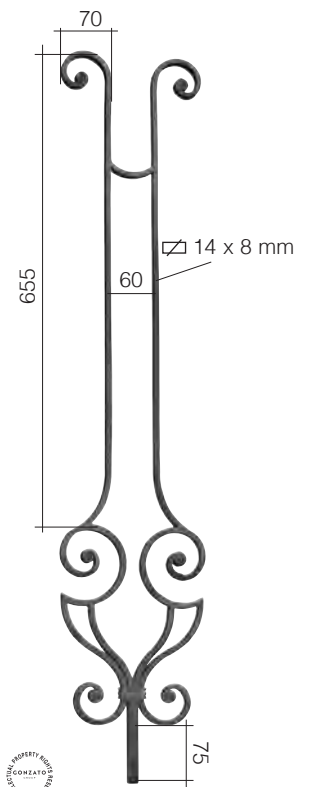

Art. GD148/1
Ø 14 x 14 mm
205 x 1000 mm

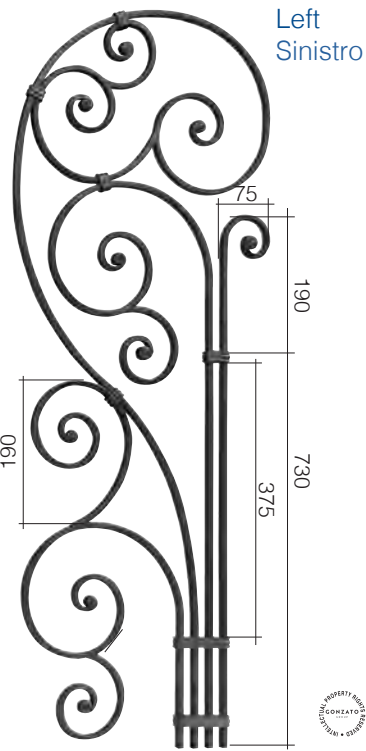

Left
Sinistro

left - sinistro
Art. GD164/1
14 x 8 mm
380 x 1000 mm

right - destro
Art. GD164/2
14 x 8 mm
380 x 1000 mm

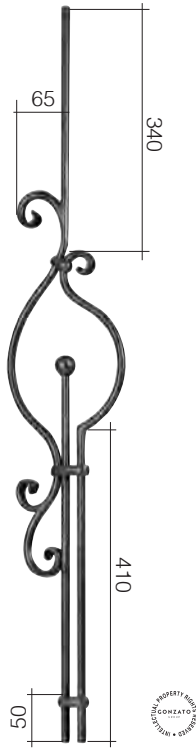

Art. GD39/3
Ø 12 mm
190 x 1000 mm

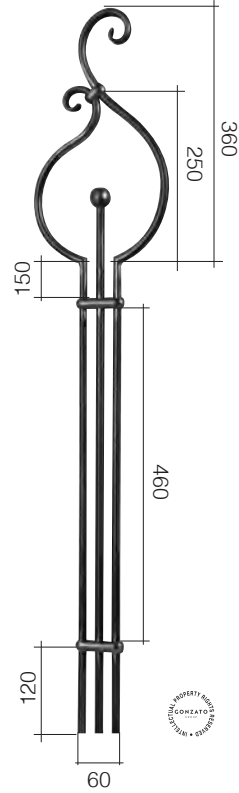

Art. GD39/1
Ø 12 mm
200 x 1000 mm

Sfere vuote Ø 30 mm
Hollow spheres Ø 30 mm

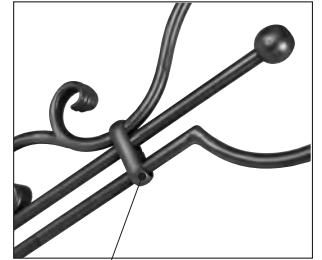

profilo/profile
art. 158/6



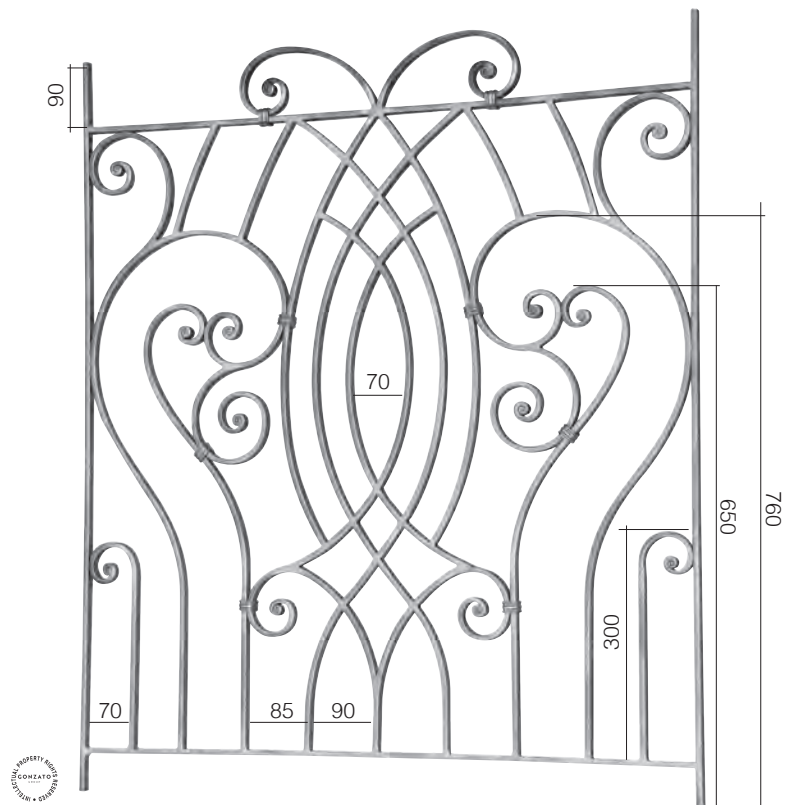
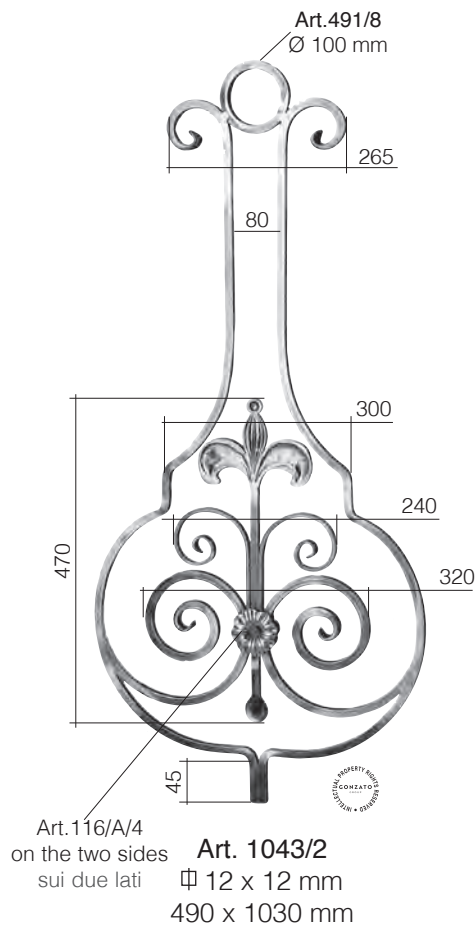

Art. GD235/1
14 x 8 mm
890 x 1000 mm

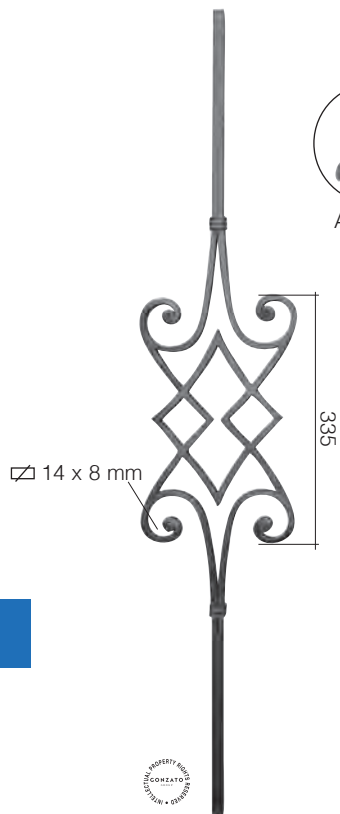

Art. GD154/3
∅ 14 mm
190 x 1000 mm



Art. GD158/1
∅ 14 x 8 mm
160 x 1000 mm

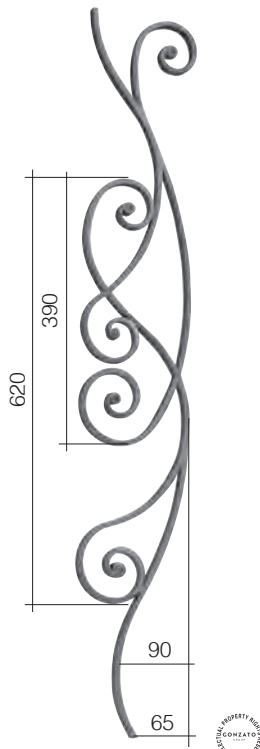

Art. GD158/2
∅ 14 x 8 mm
160 x 1000 mm

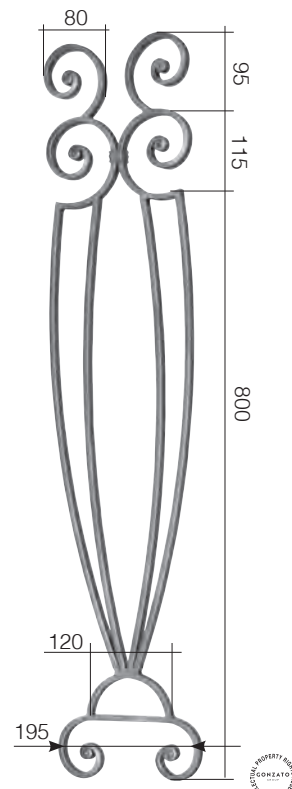

Art. GD175/7
∅ 14 x 8 mm
200 x 1000 mm



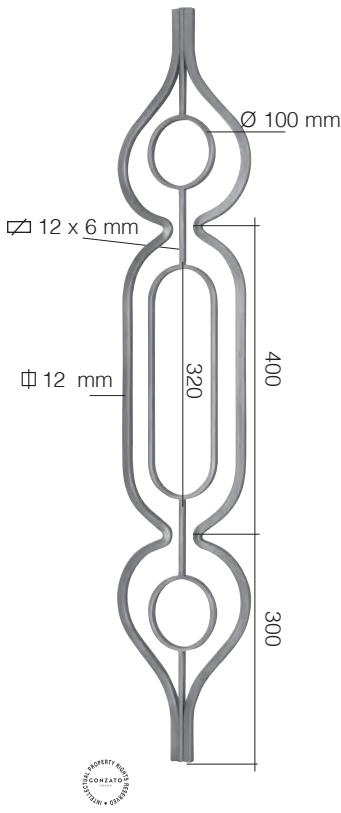

Art. GD69/1
12 mm
210 x 1000 mm

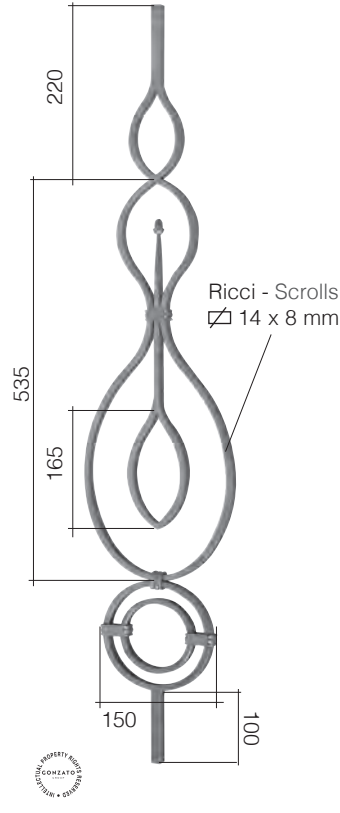

Art. GD177/1
14 mm
205 x 1000 mm

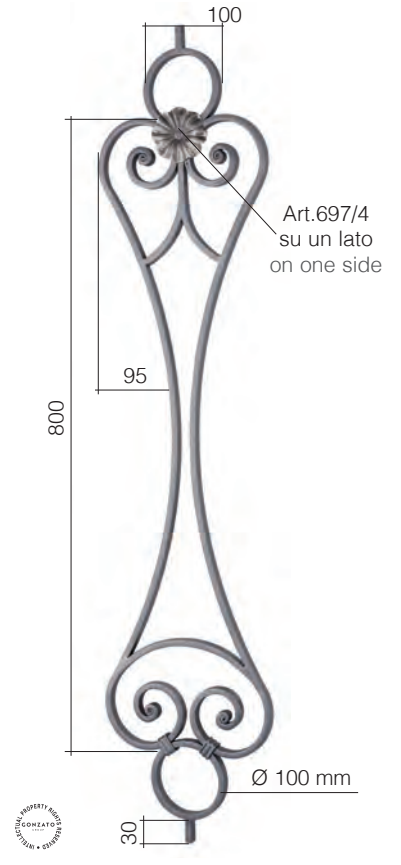

Art. GD280/2
14 x 8 mm
225 x 1000 mm

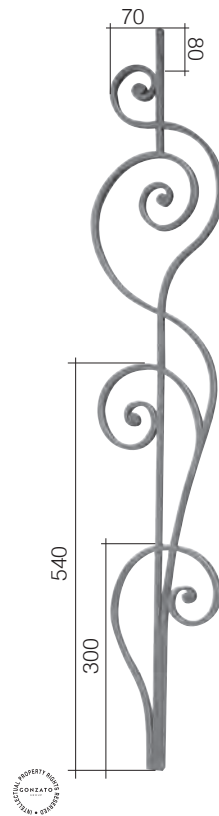

Art. GD228/2
14 x 8 mm
190 x 1000 mm

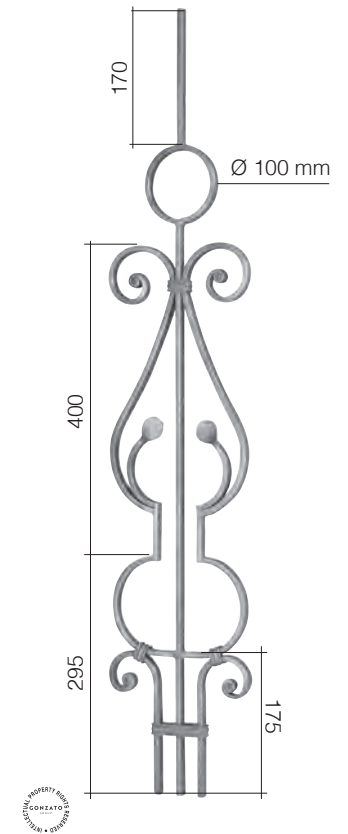

Art. GD166/2
14 x 8 mm
200 x 1000 mm

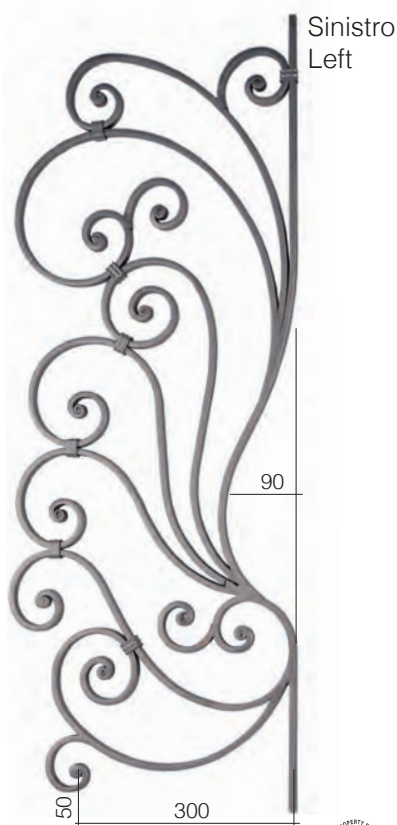

left - sinistro
Art. GD283/2
14 x 8 mm
380 x 1000 mm

right - destro
Art. GD283/4
14 x 8 mm

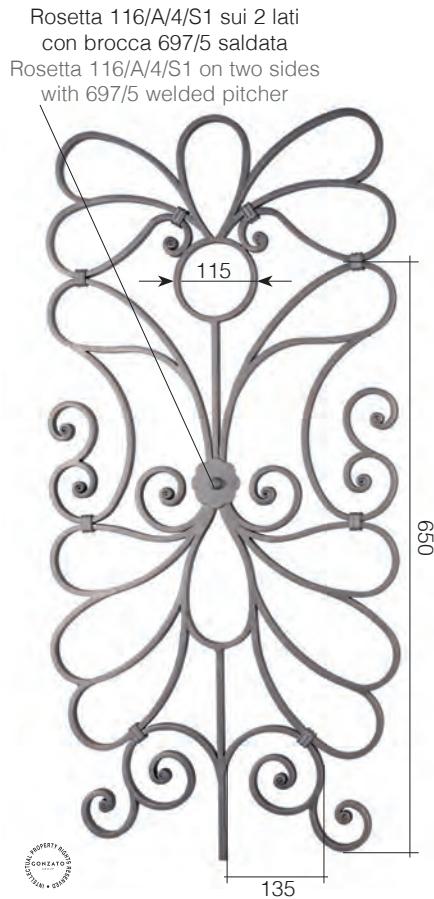

Rosetta 116/A/4/S1 sui 2 lati
con brocca 697/5 saldata
Rosetta 116/A/4/S1 on two sides
with 697/5 welded pitcher

Art. GD282/1
14 x 8 mm
490 x 1000 mm



Rosetta 116/A/4/S1 sui 2 lati
con brocca 697/5 saldata
Rosetta 116/A/4/S1 on two sides
with 697/5 welded pitcher

Art. GD284/2
14 x 8 mm
400 x 885 mm

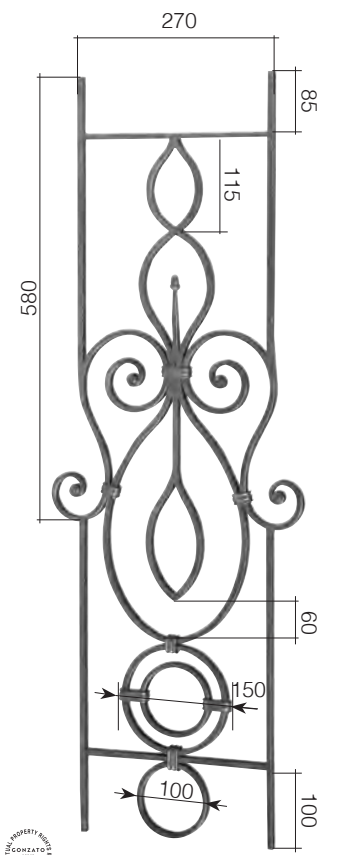

Art. GD177/2
14 x 8 mm
350 x 1000 mm

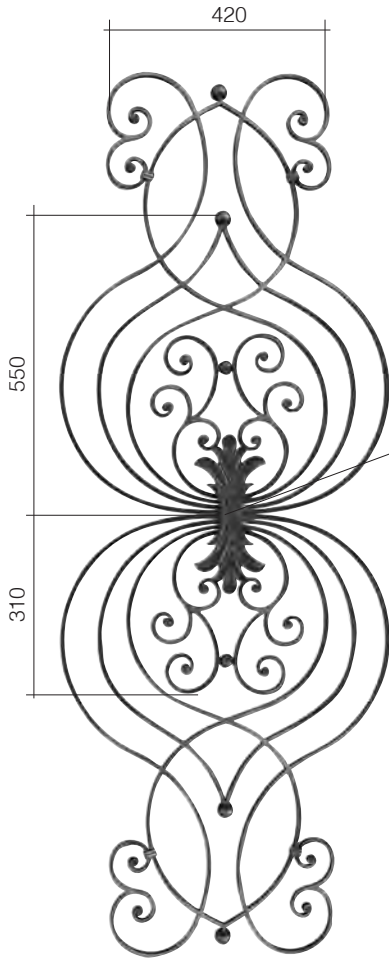

Art. GD231/1
14 x 8 mm
600 x 1600 mm



Ø 30 mm
art. 116/F/3
art. NEW0050
sui due lati
on both sides

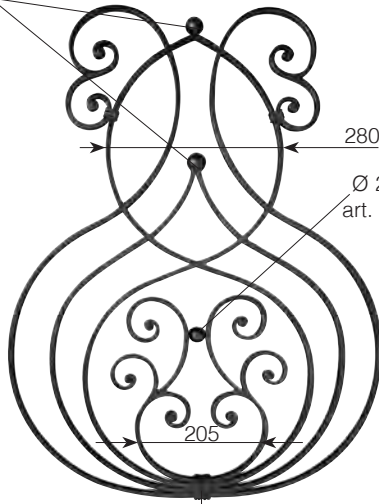

Ricci - Scrolls
14 x 8 mm

Art. GD231/2
14 x 8 mm
600 x 800 mm



profilo/profile
art. 158/49



Art. GD206/1
14 x 8 mm
420 x 1000 mm

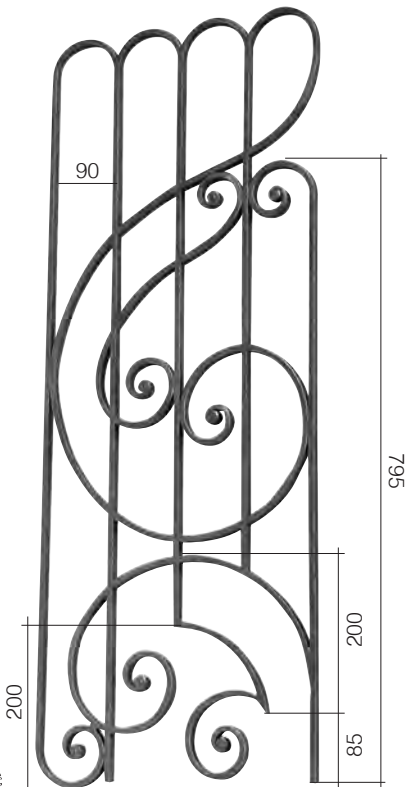

Art. GD225/1
14 x 8 mm
385 x 1000 mm



Scrolls - Ricci
16 x 6 mm

Art. GD239/4
on both sides
su 2 latii lati

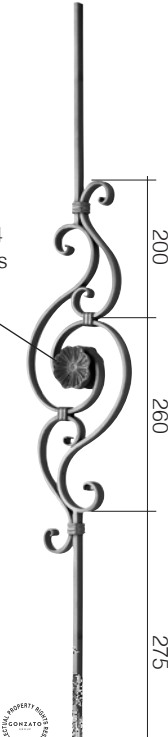

Art. GD271/5
16 x 8 mm
175 x 1000 mm



Art. GD239/4
su entrambi i lati
on two sides

Ricci - Scrolls
16 x 6 mm

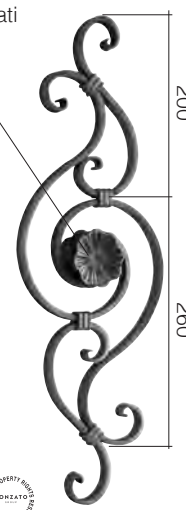

Art. GD271/4
16 x 6 mm
175 x 510 mm



Stop met het verspillen van tijd.

Investeer in plaats daarvan in onze samenwerking en lever gegarandeerd de beste oplossing aan jouw klant!

Met vriendelijke groet,
Team Mauriks



Direct contact

+31 (0)73 646 11 00

info@maurikssolutions.com

Bezoek showroom & kenniscentrum

Australiëlaan 10

5232 BB 's-Hertogenbosch (NL)

(Tradepark De Herven - Pand nr. 3181)

www.maurikssolutions.com

mauriks
solutions